

(PL) Instrukcja montażu

(GB) Assembly instructions

(DE) Montageanleitung

(FR) Notice de montage

(IT) Istruzioni di montaggio

(NL) Montage-instructies

>5F 8-B ; %&

UWAGA /REMARQUE/ /NOTE/ ATATTENZIONE /HINWEIS /LETOP

(PL) Maksymalna wysokość słupa wody ~ 1.2 m

(FR) Niveau maximum de la colonne d'eau ~ 1.2 m

(GB) The maximum water column level ~ 1.2 m

(IT) Livello massimo della colonna d'acqua ~ 1.2 m

(DE) Maximaler Wasserstand ~ 1.2 m

(NL) Maximum niveau waterkolom ~ 1.2 m

Objętość wody w basenie 34.21 m³

Le volume de l'eau dans la piscine 34.21 m³

Water capacity in the pool 34.21 m³

Il volume di acqua in piscina 34.21 m³

Volumen von Wasser im Schwimmbecken 34.21 m³

Water inhoud van het zwembad 34.21 m³

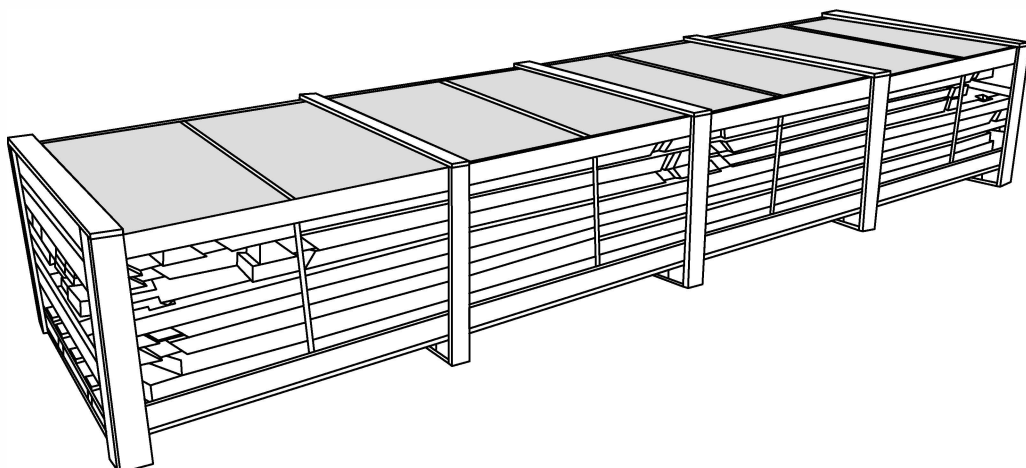
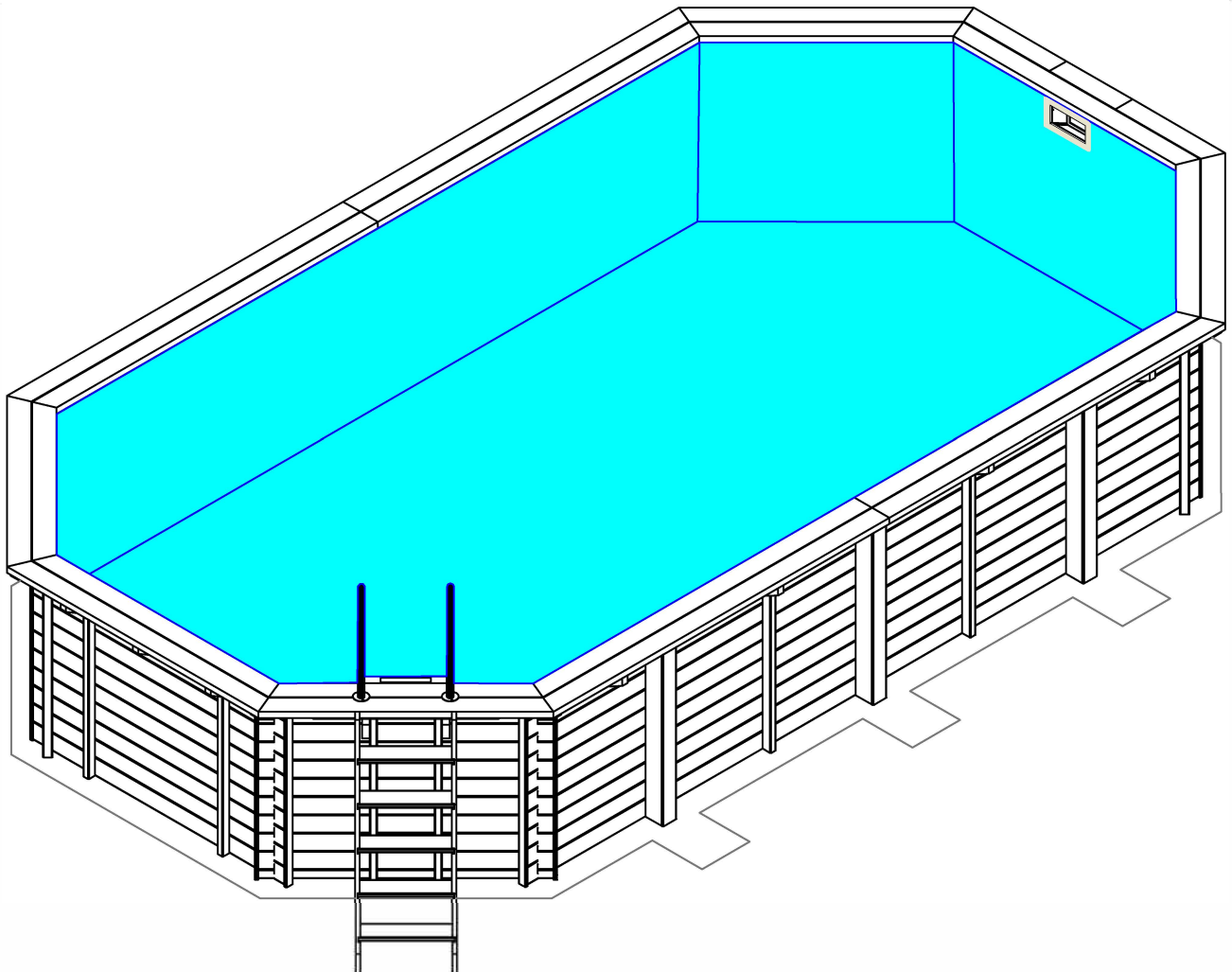

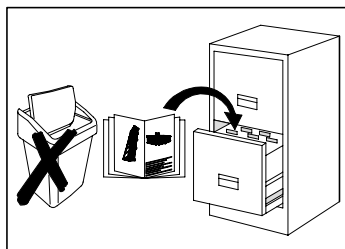
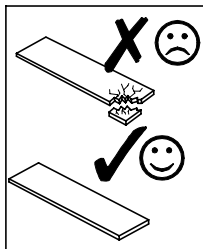
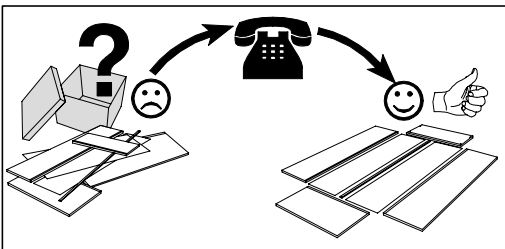
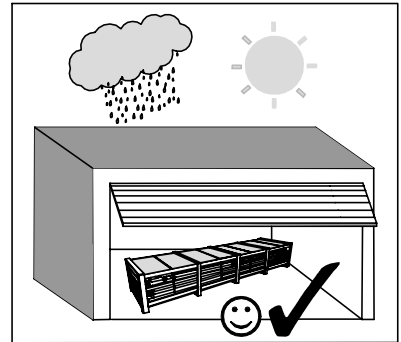
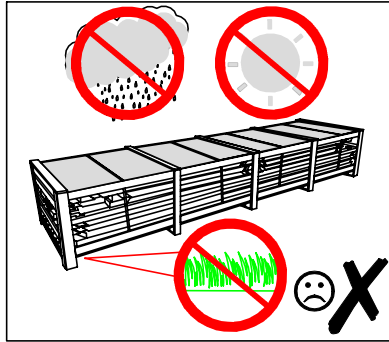
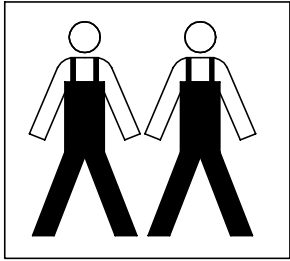
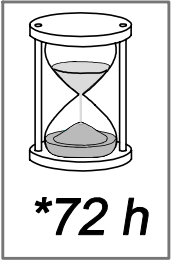

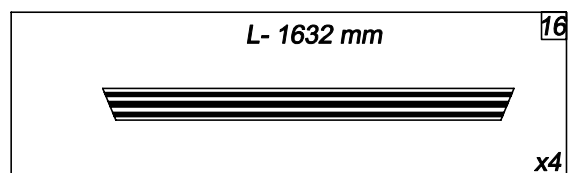
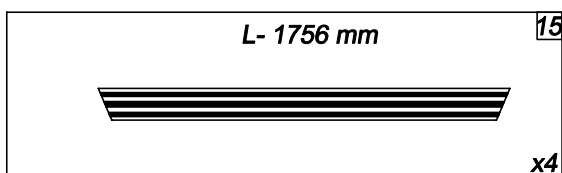
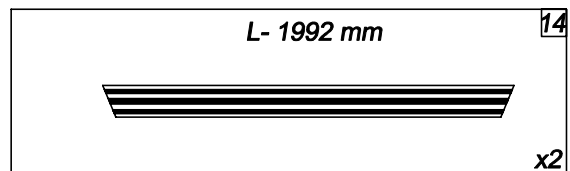
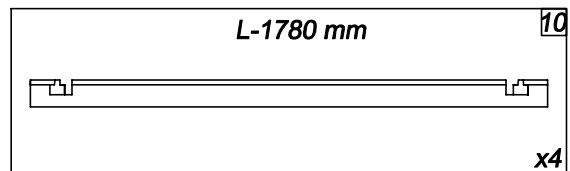
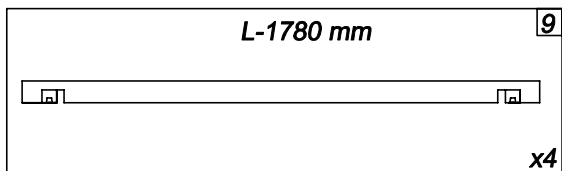
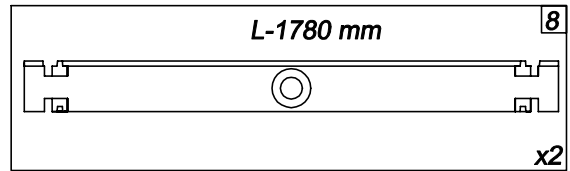
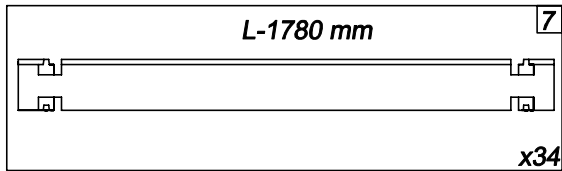
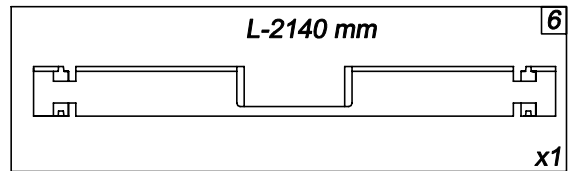
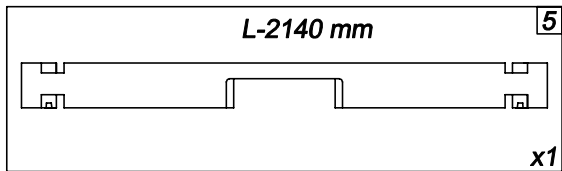
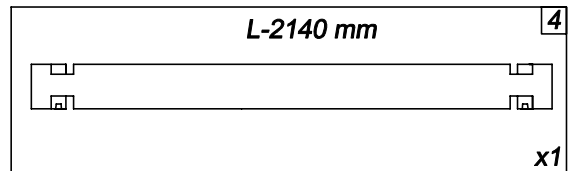
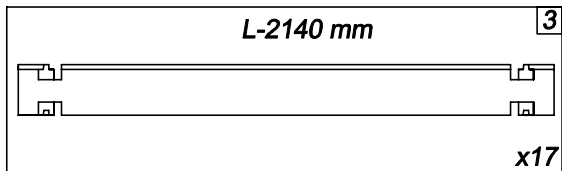
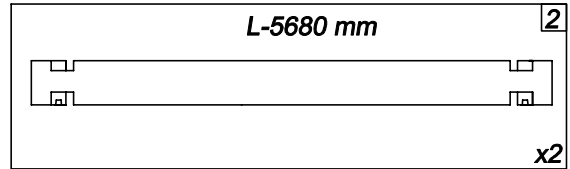
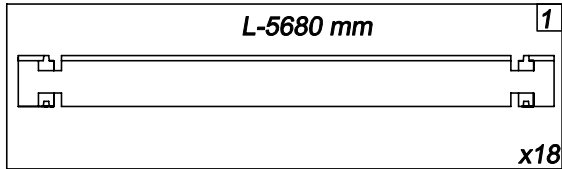
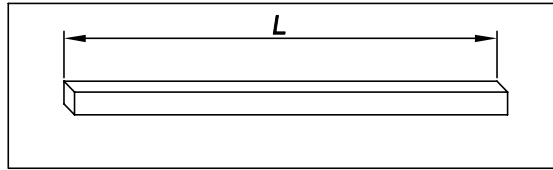

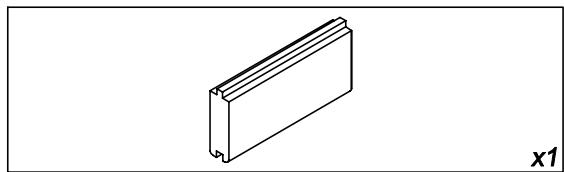
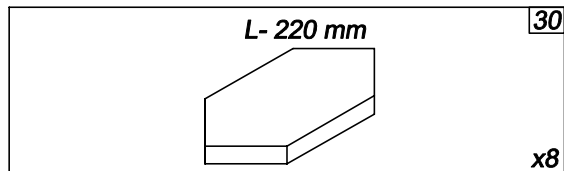
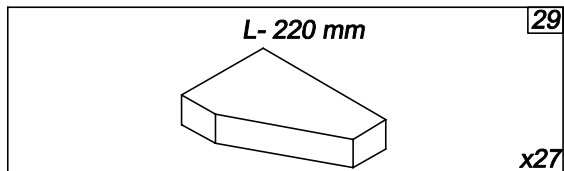
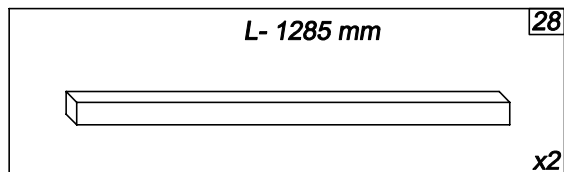
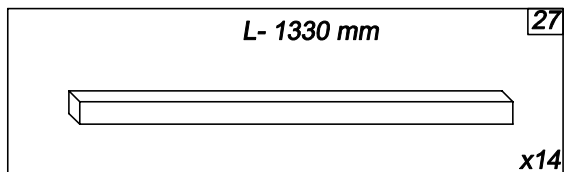
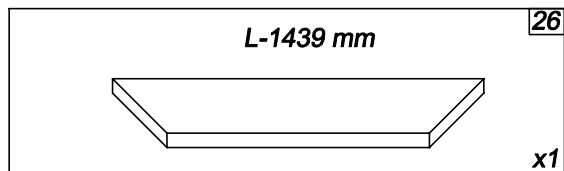
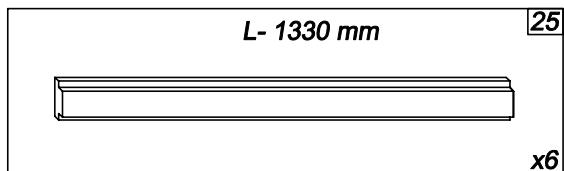
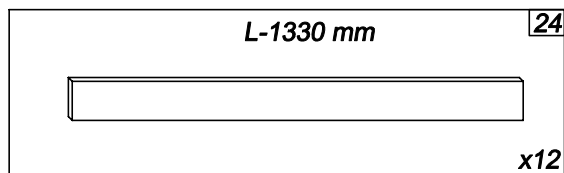
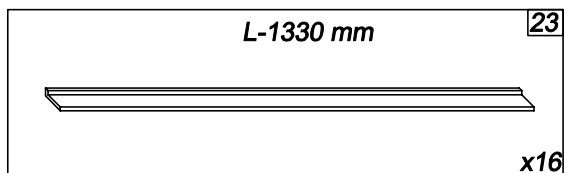
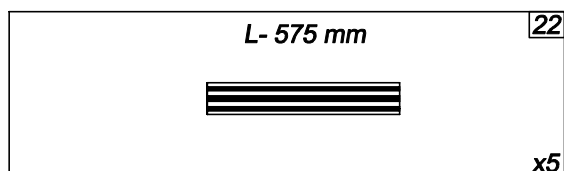
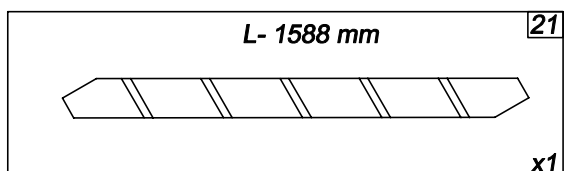
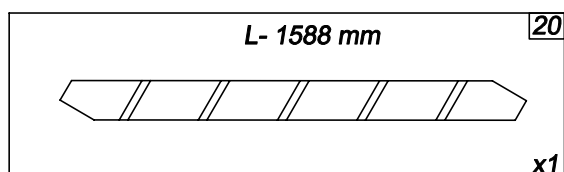
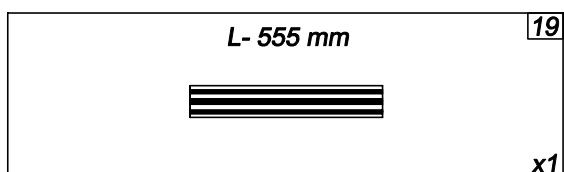
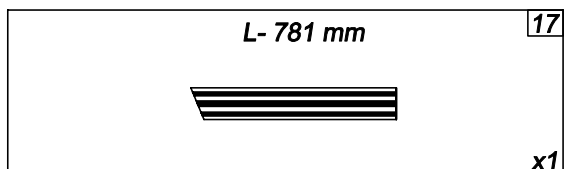
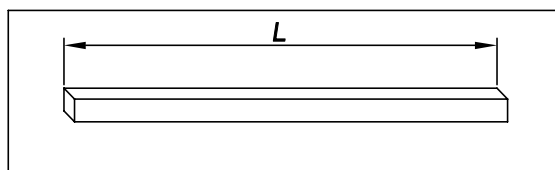
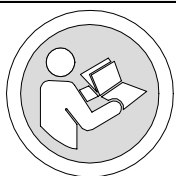

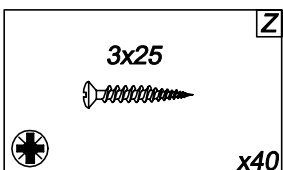
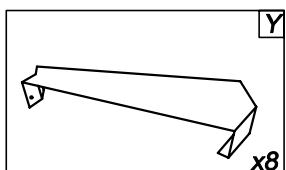
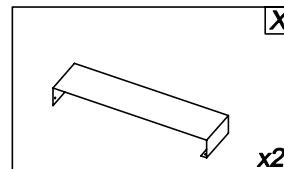
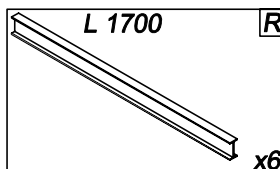
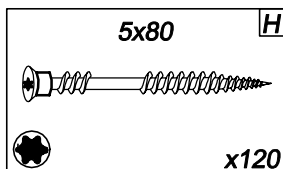
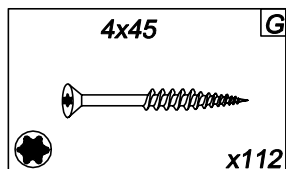
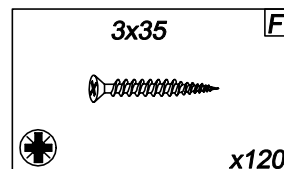
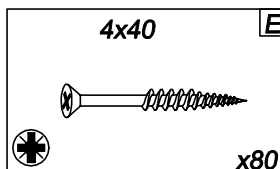
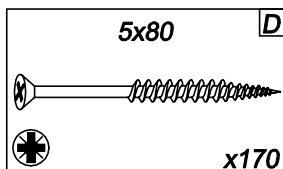
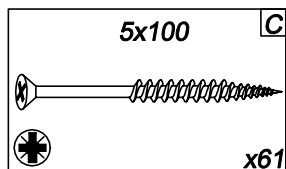
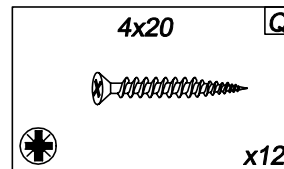
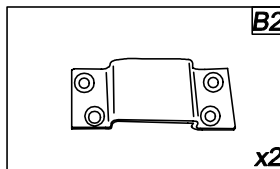
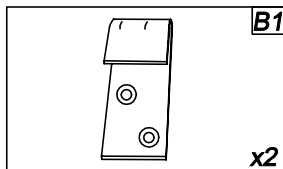
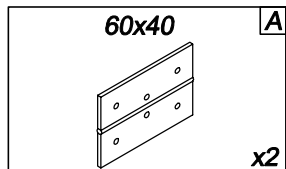

PL Podłoże

GB Ground

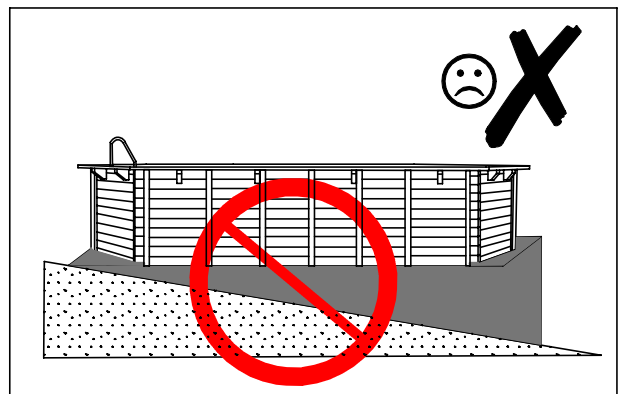
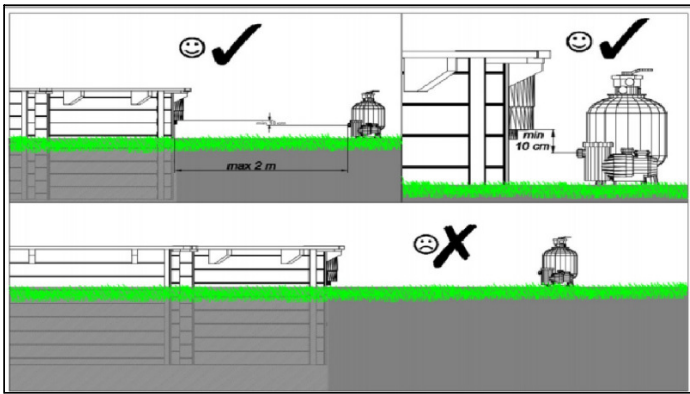
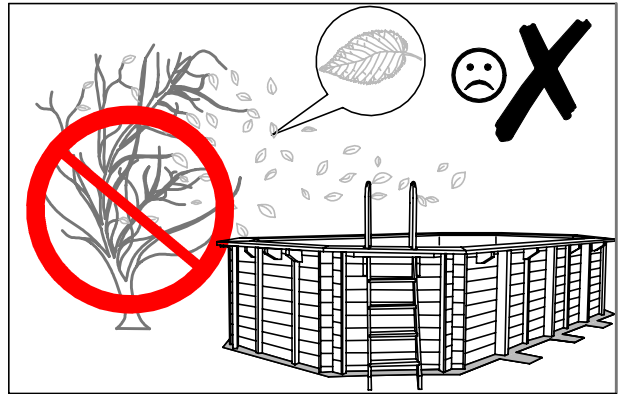
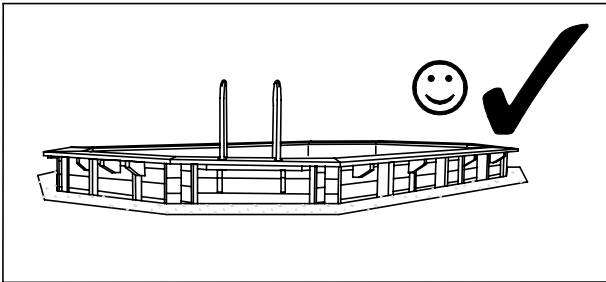
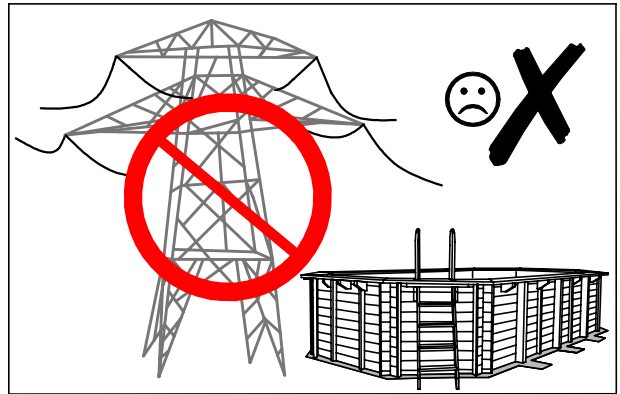
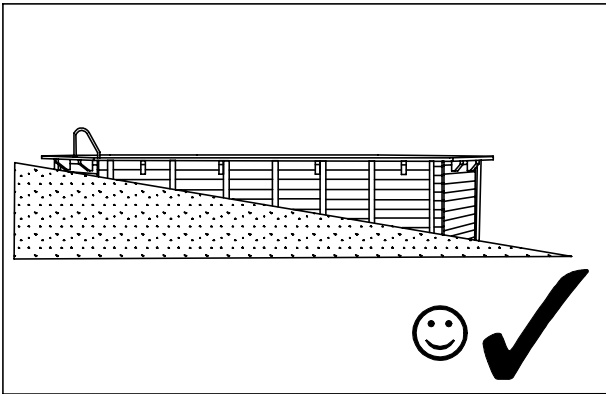
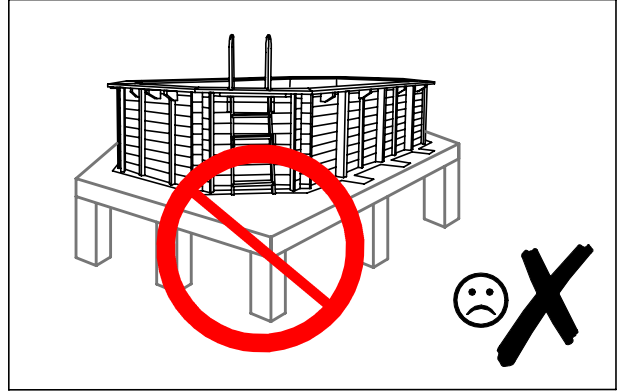
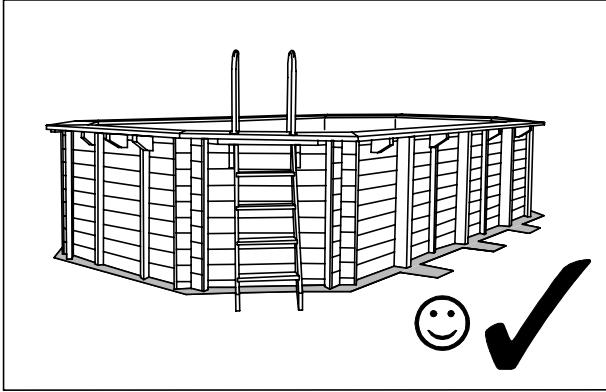



- 1** FUNDAMENT BASENU / *FUNDATION*
- 2** RURA DRENARSKA / *DRAINAGE PIPE*
- 3** PĘCHERZYKOWA FOLIA FUNDAMENTOWA / *FOINDATION BUBBLE WRAP*
- 4** ŻWIR / *GRAVEL*
- 5** GEOWŁÓKNINA OGRODOWA / *GEOTEXTILE*
- 6** GRUNT / *GROUND*

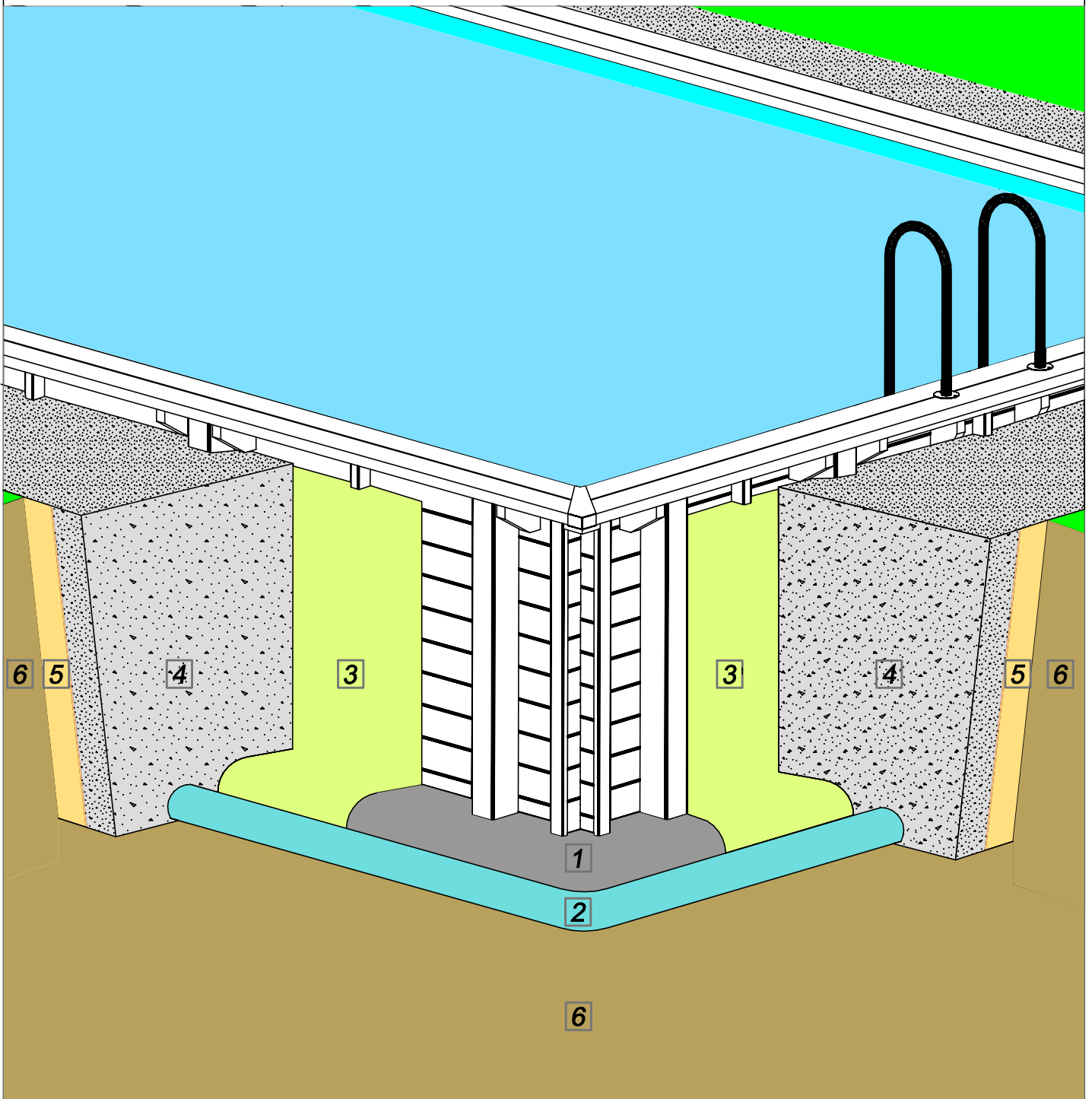

PL Podłoże

GB Ground

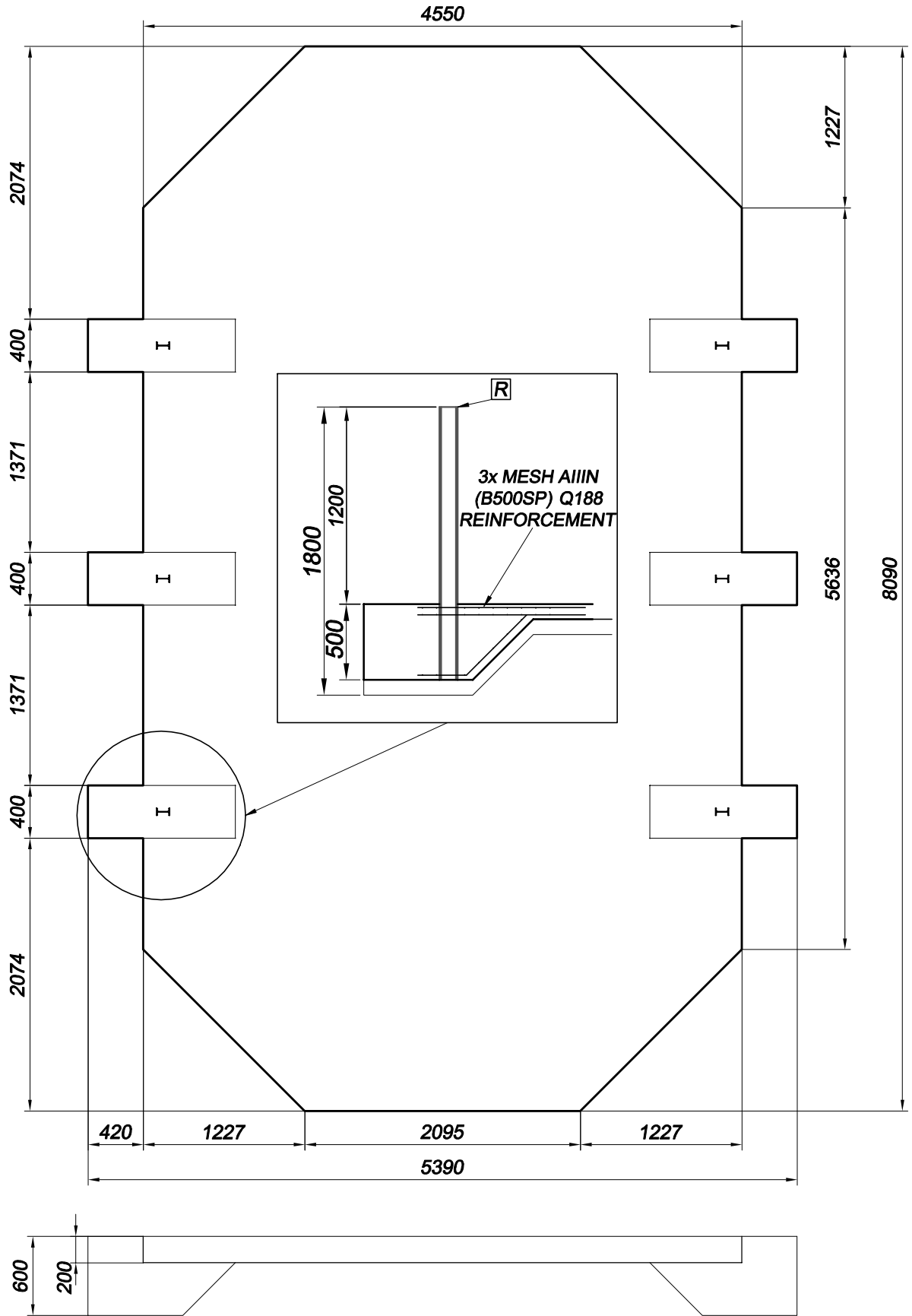

PL Podłoże

GB Ground

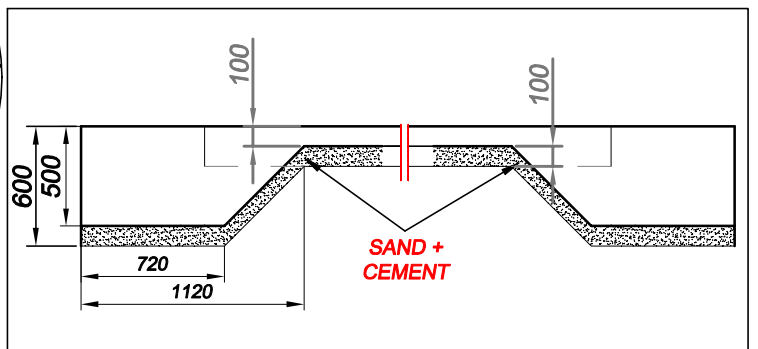
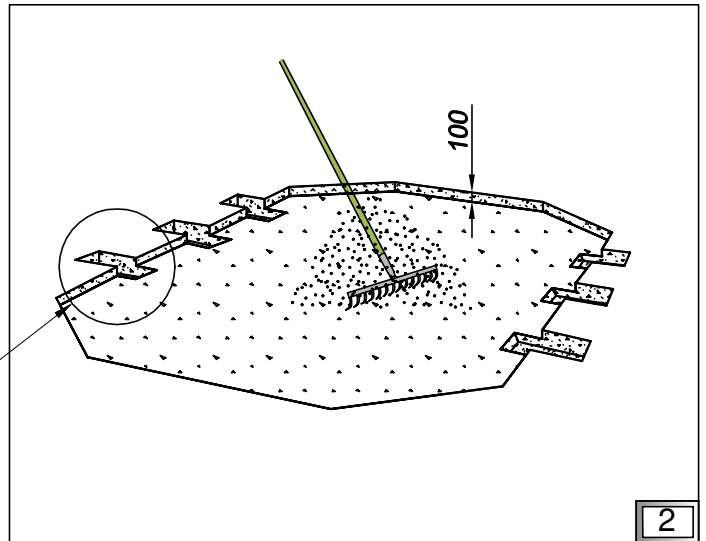
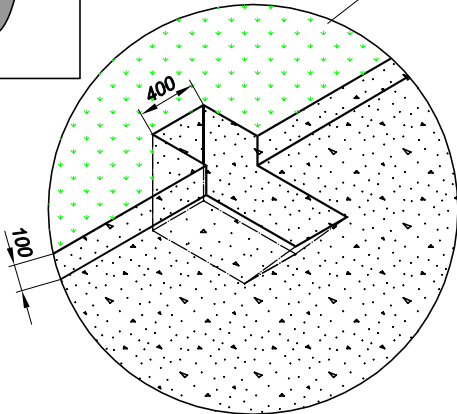
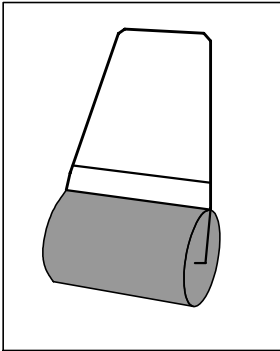
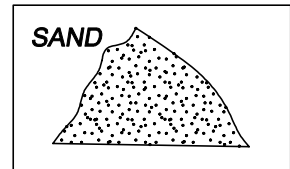
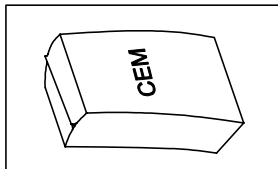
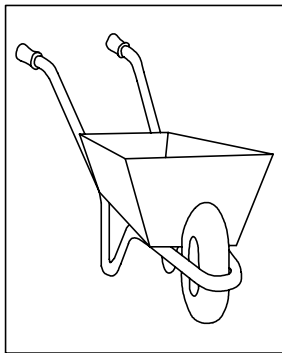
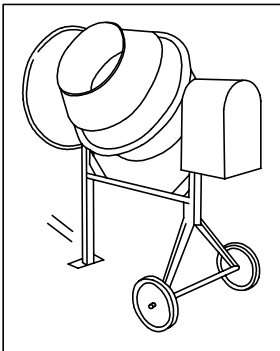
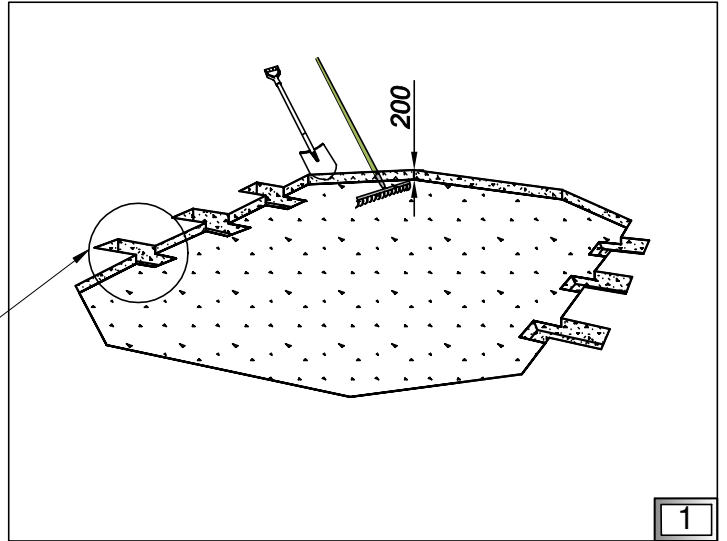
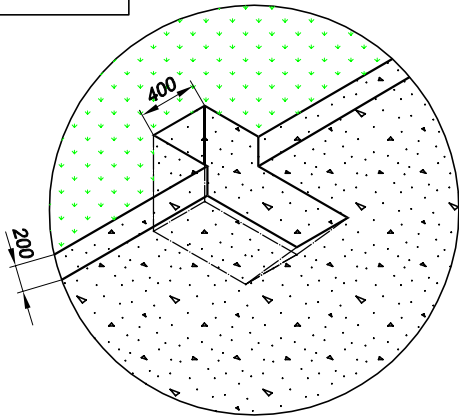
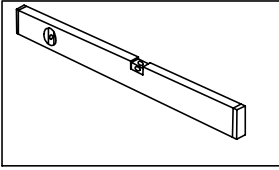

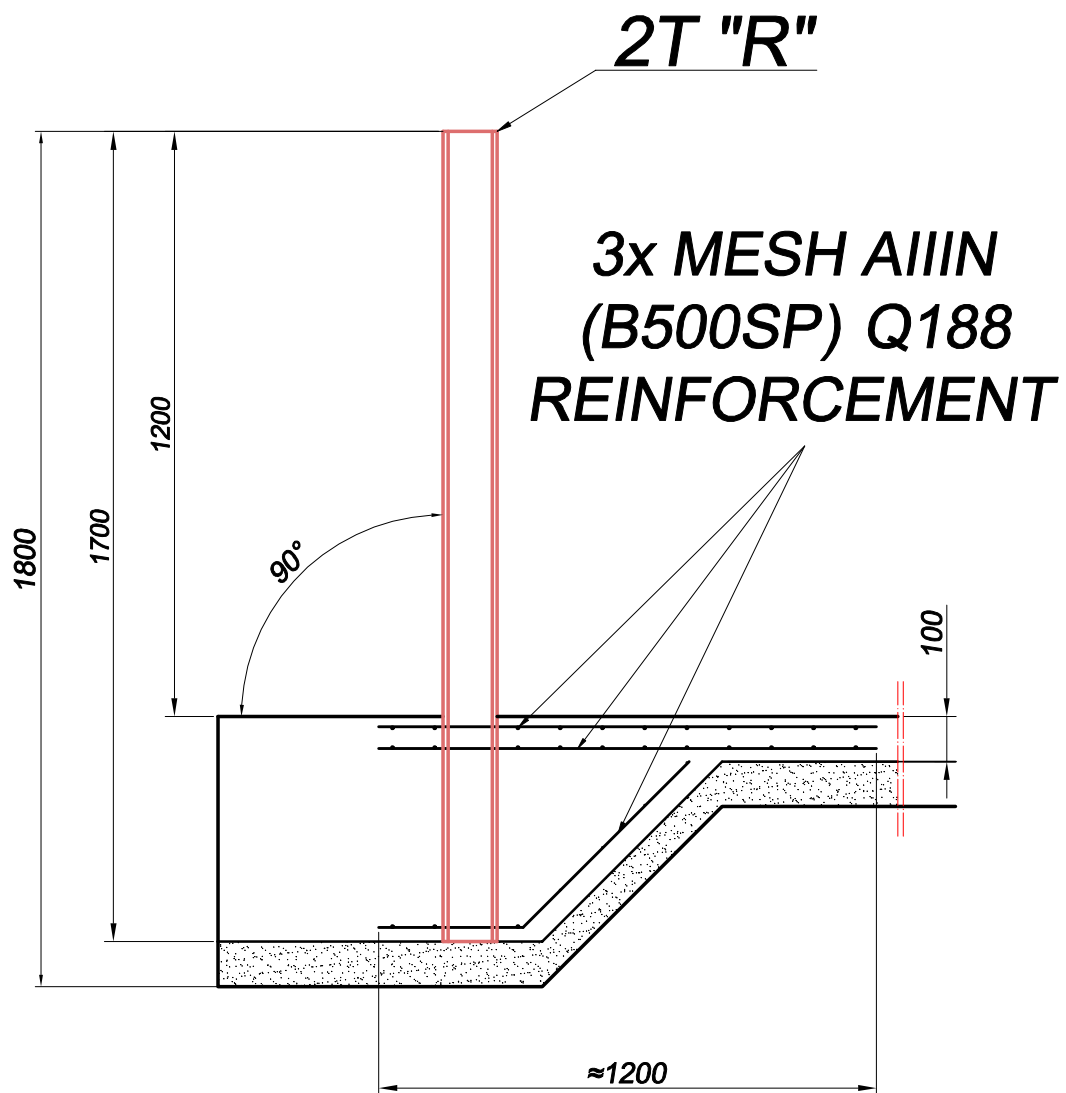

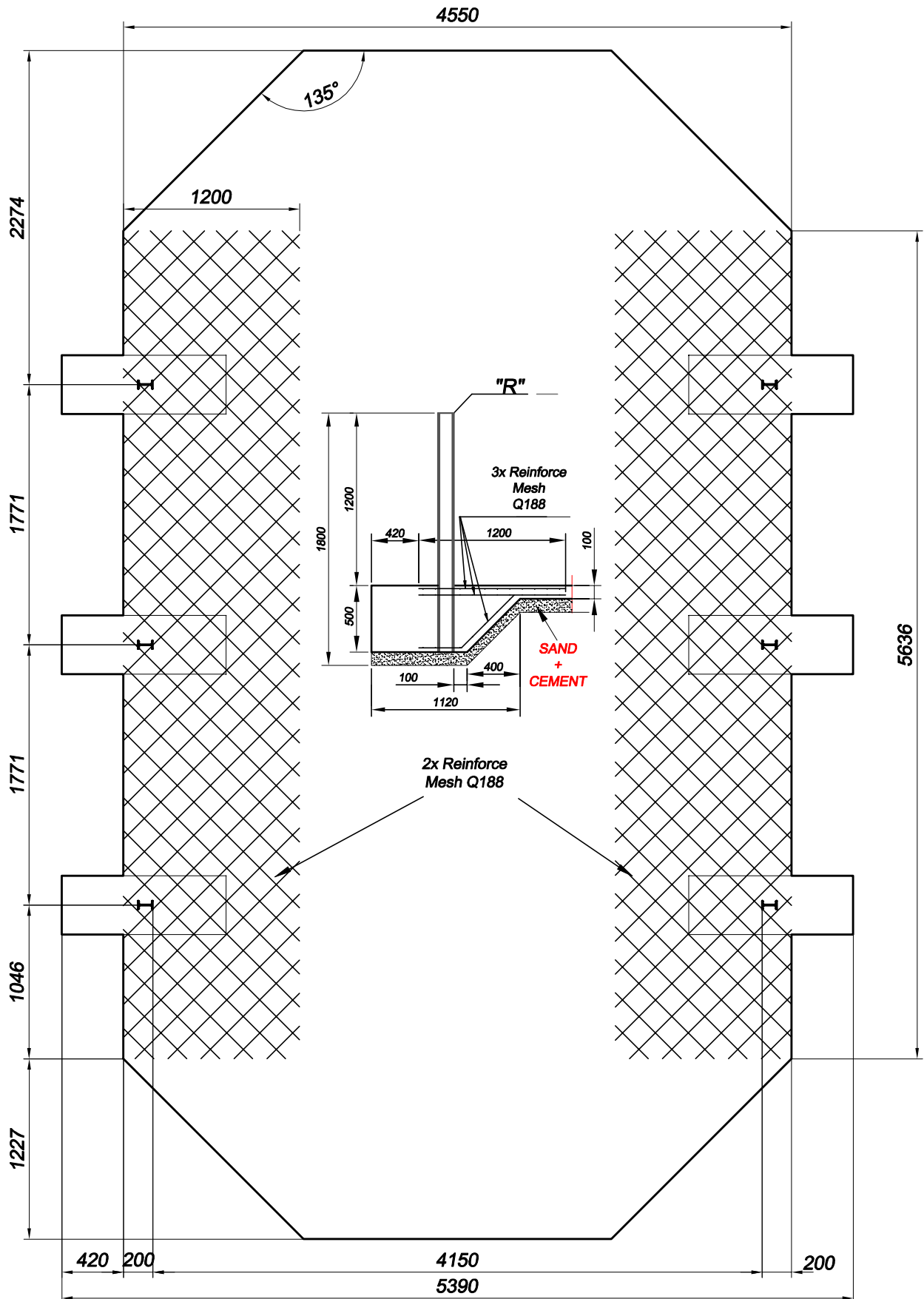

PL Podłóże

GB Ground

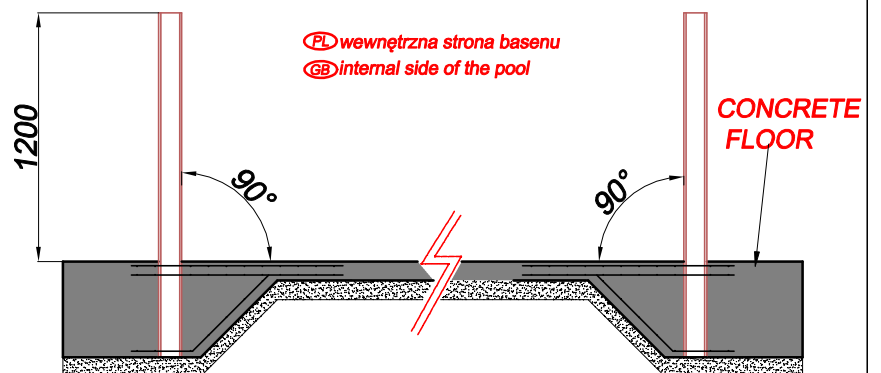
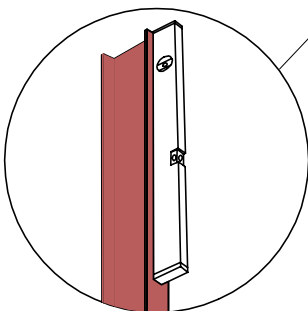
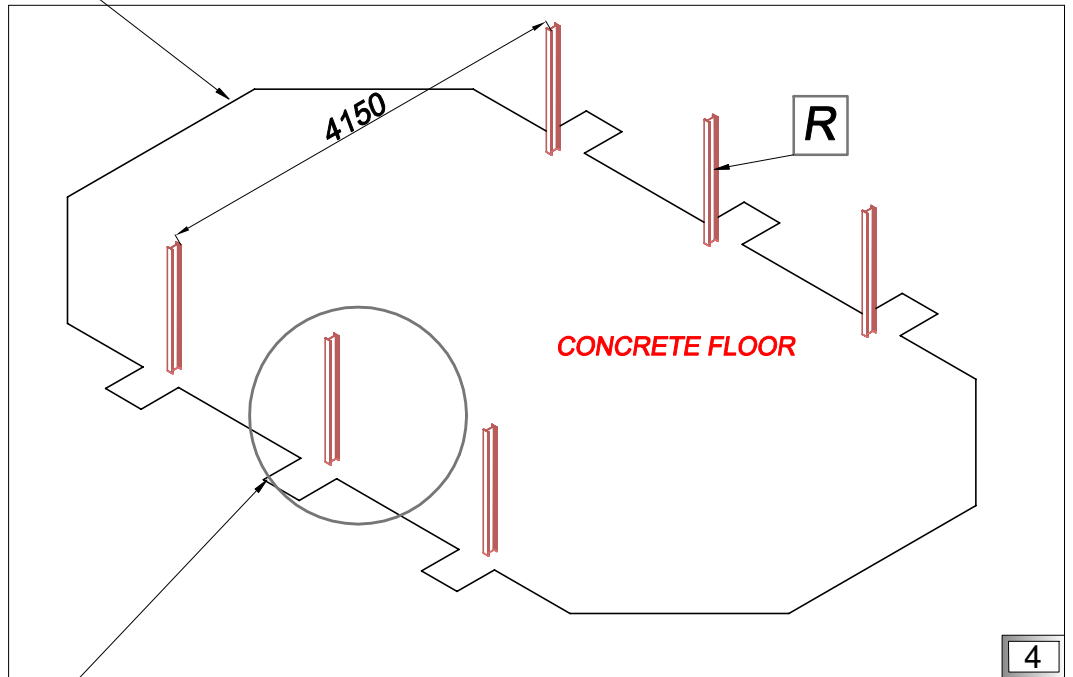
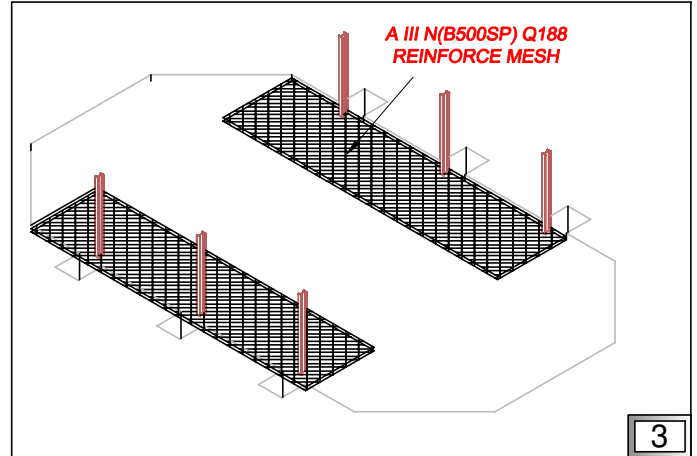
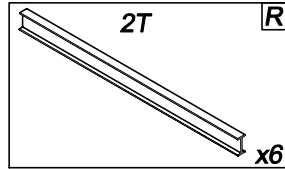
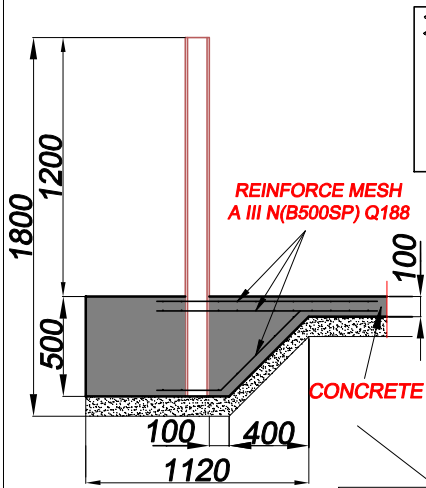
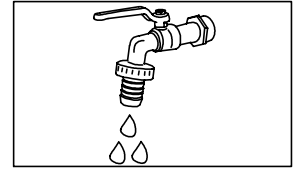
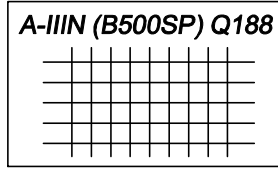
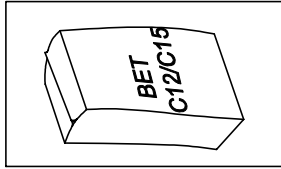

PL Podłoże

GB Ground

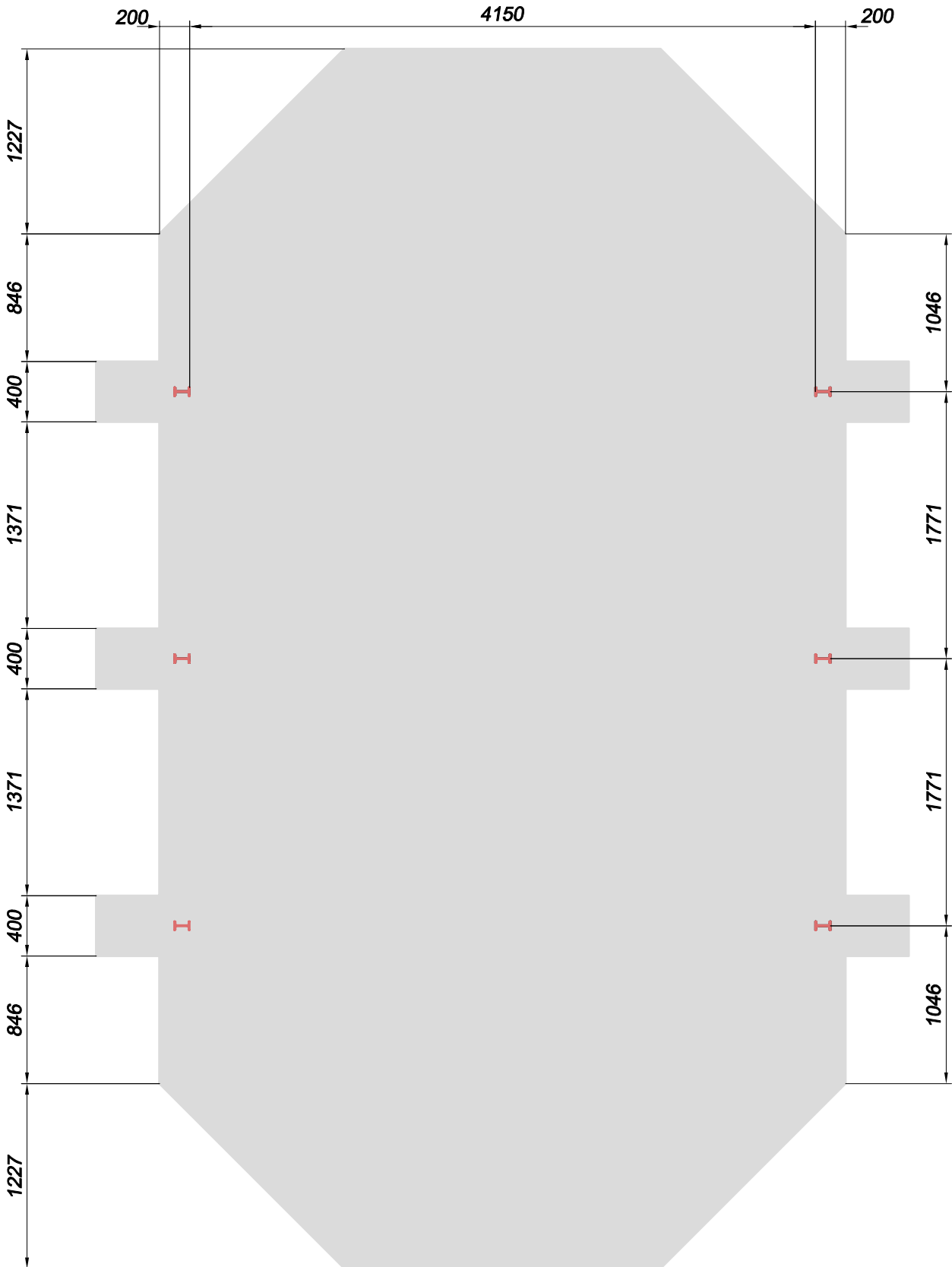



I

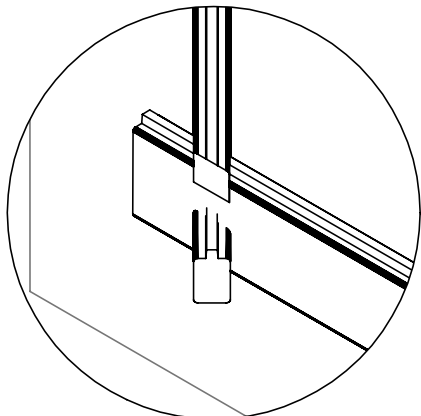
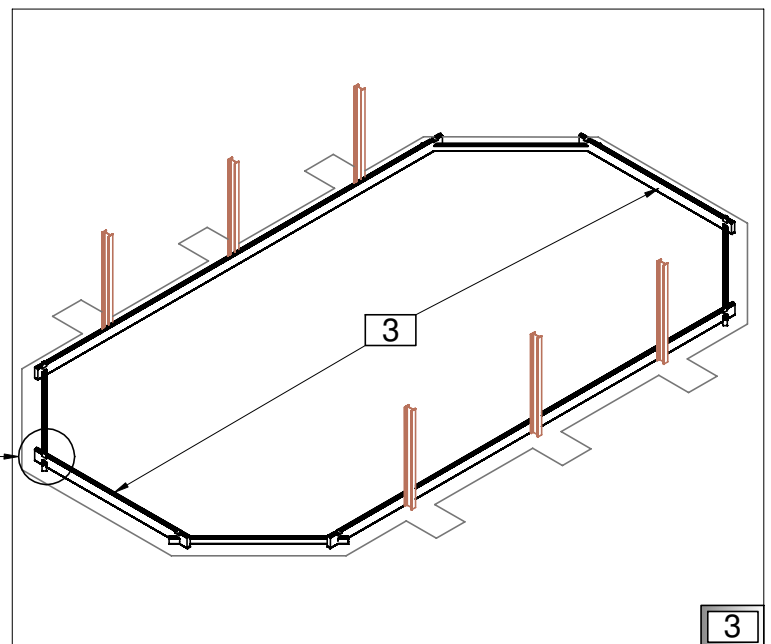
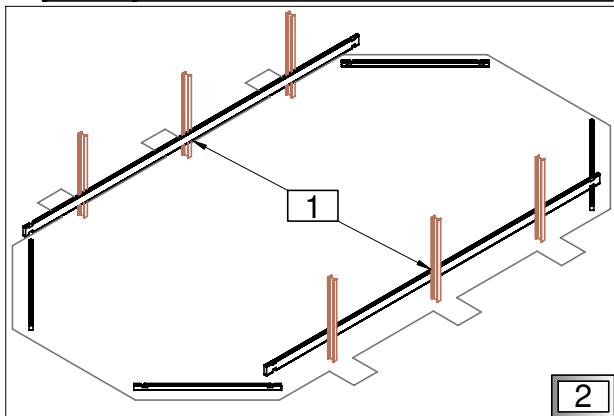
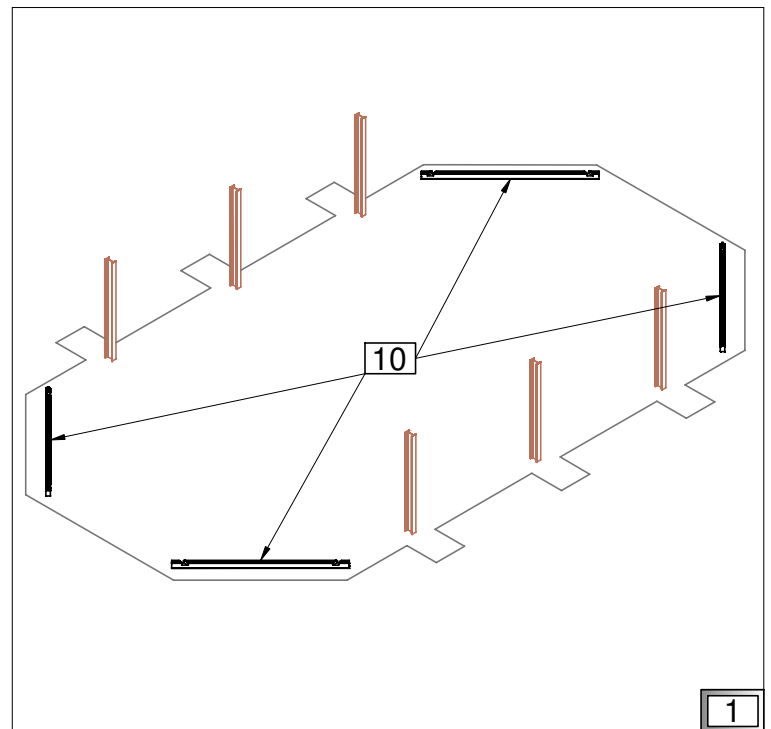
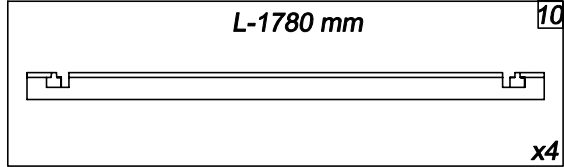
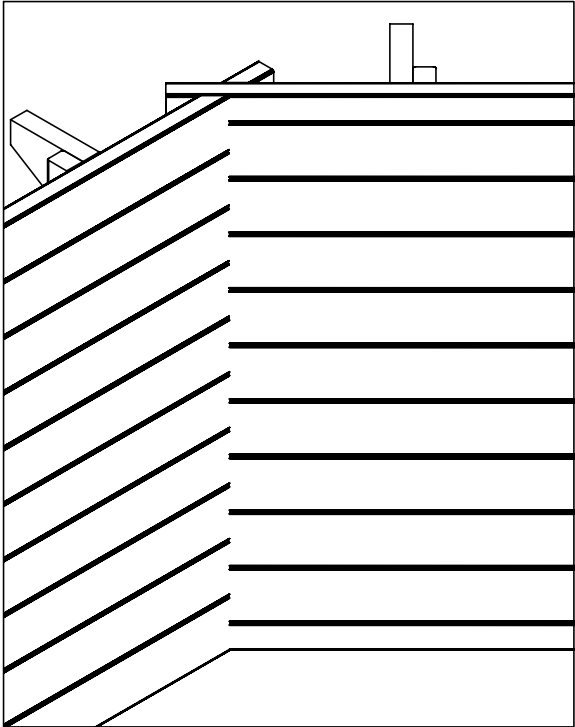
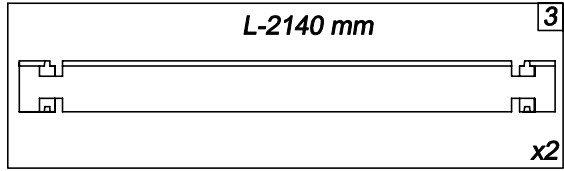
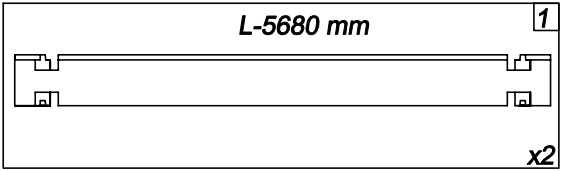

PL *Struktura drewniana*

GB *Wooden structure*

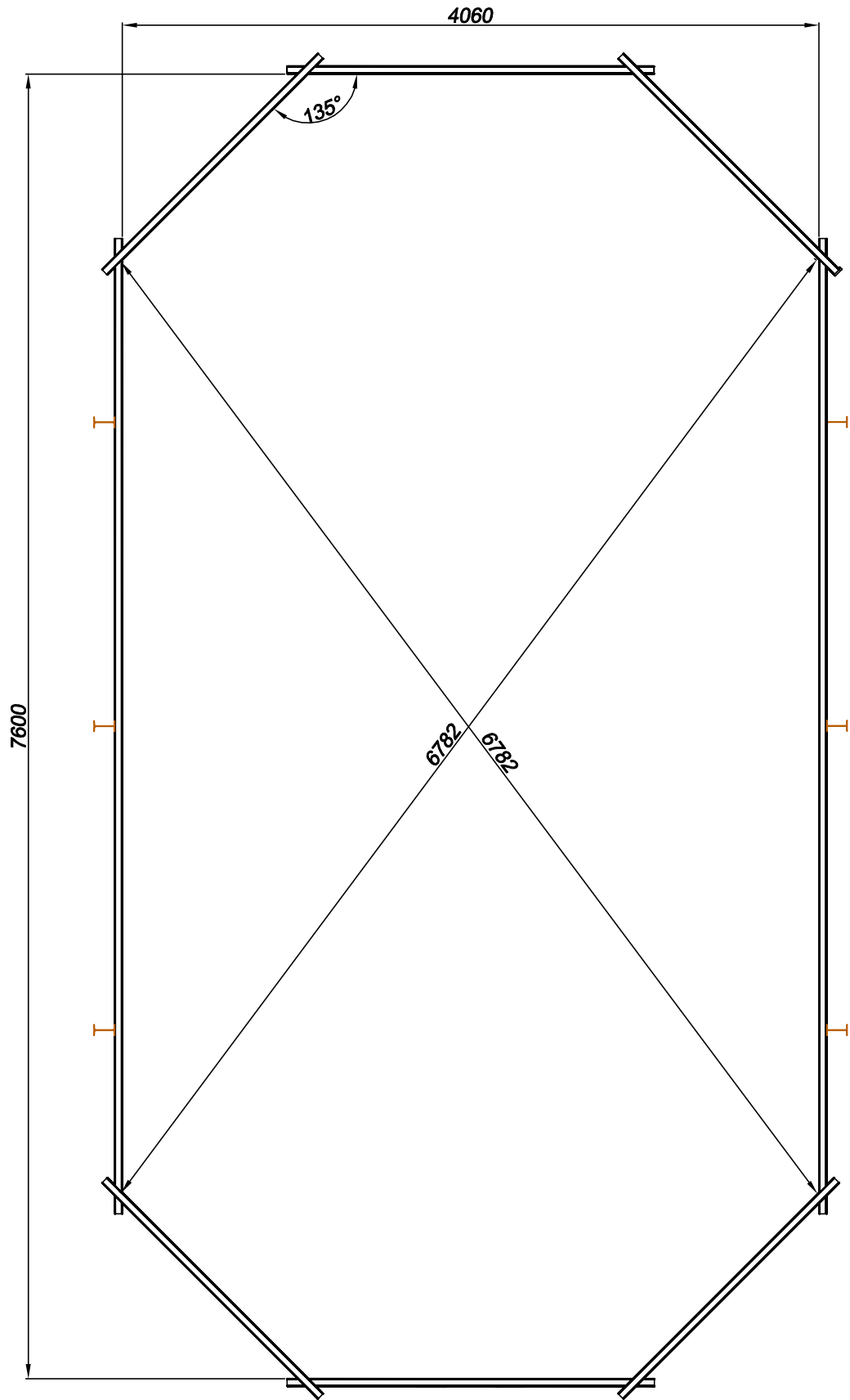



II-IV

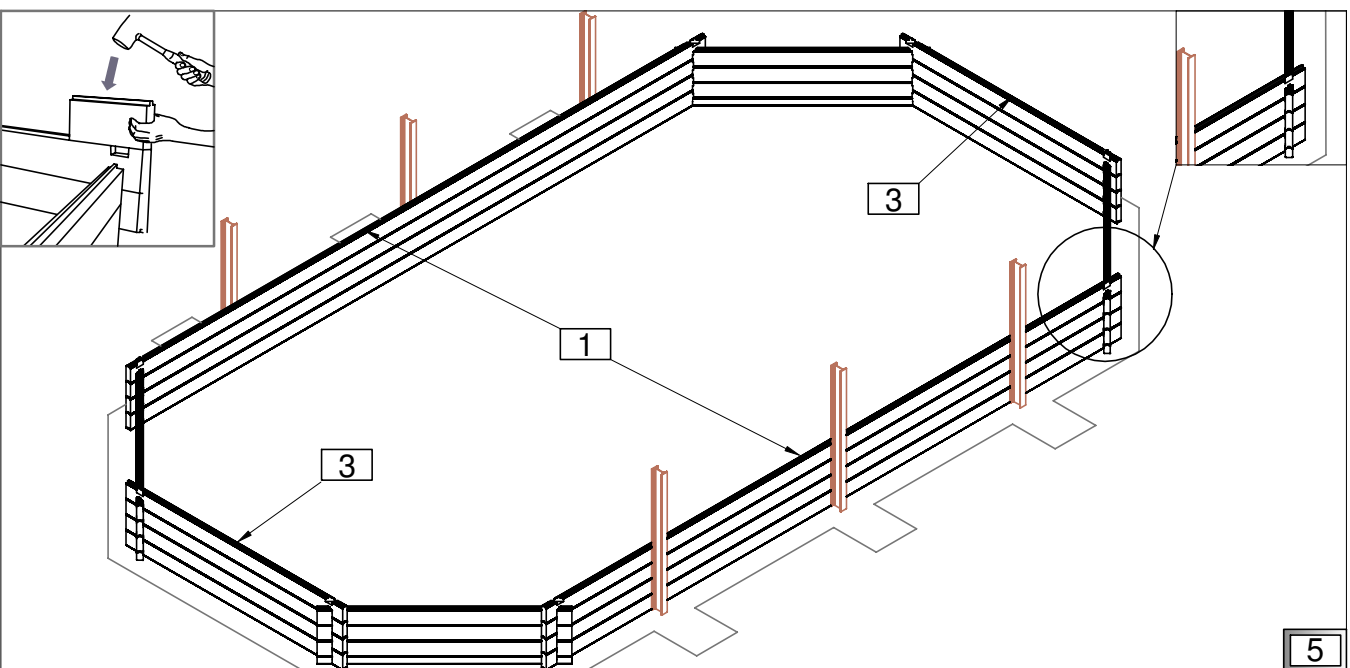
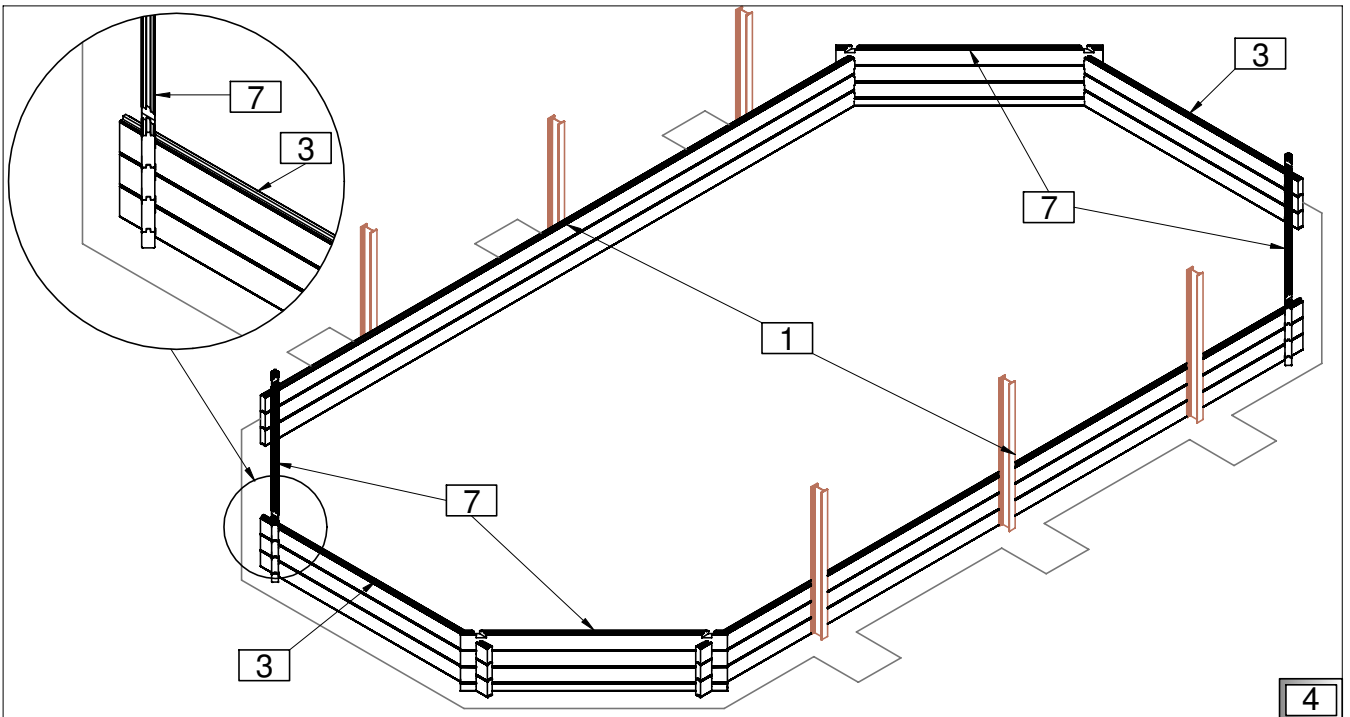
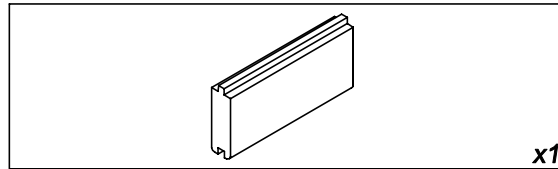
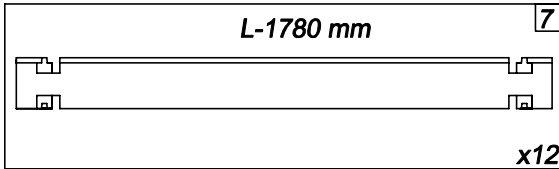
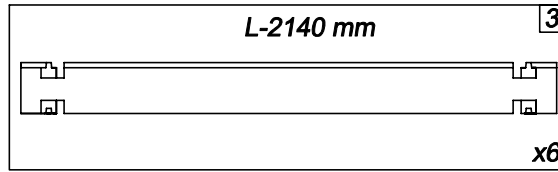
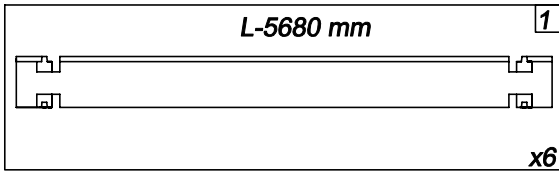

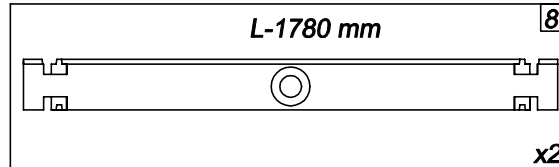
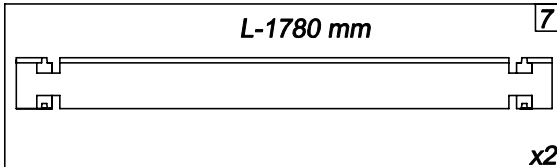
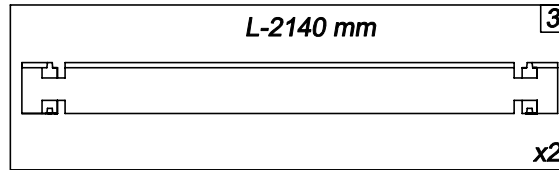
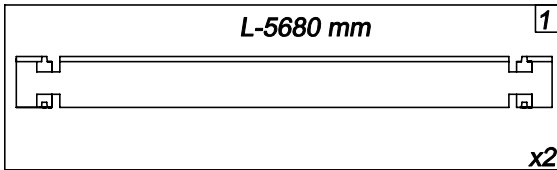

V

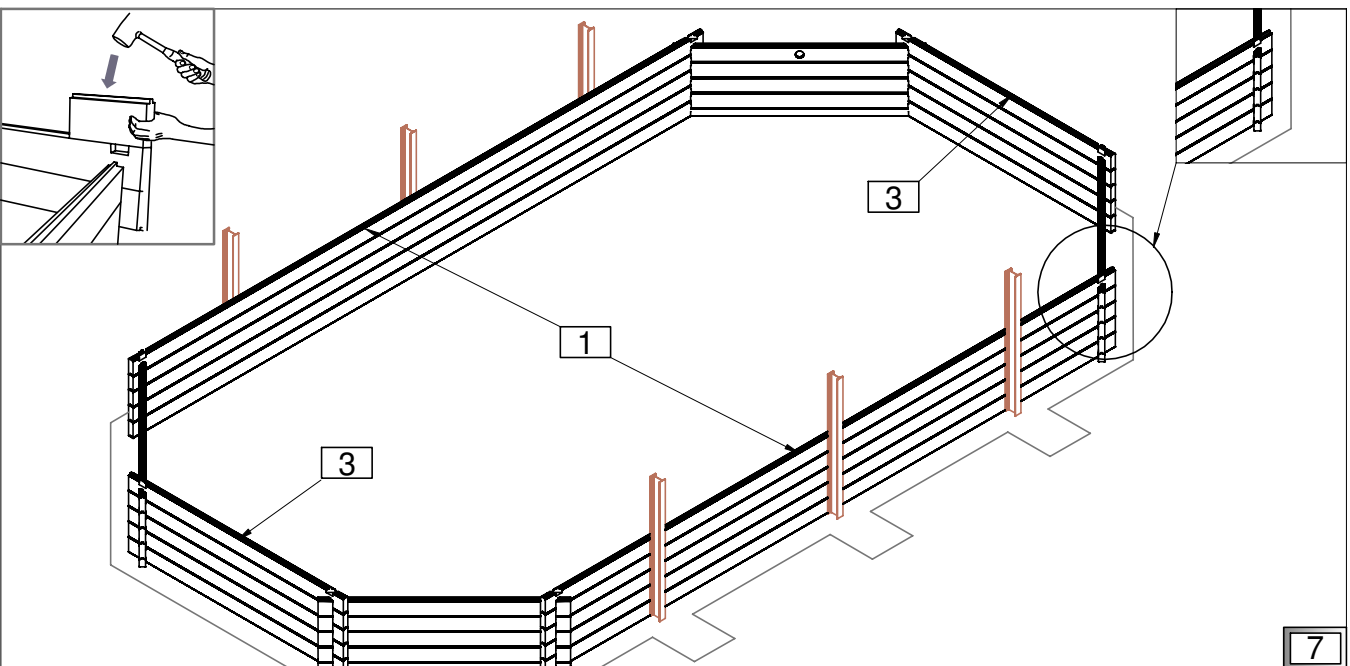
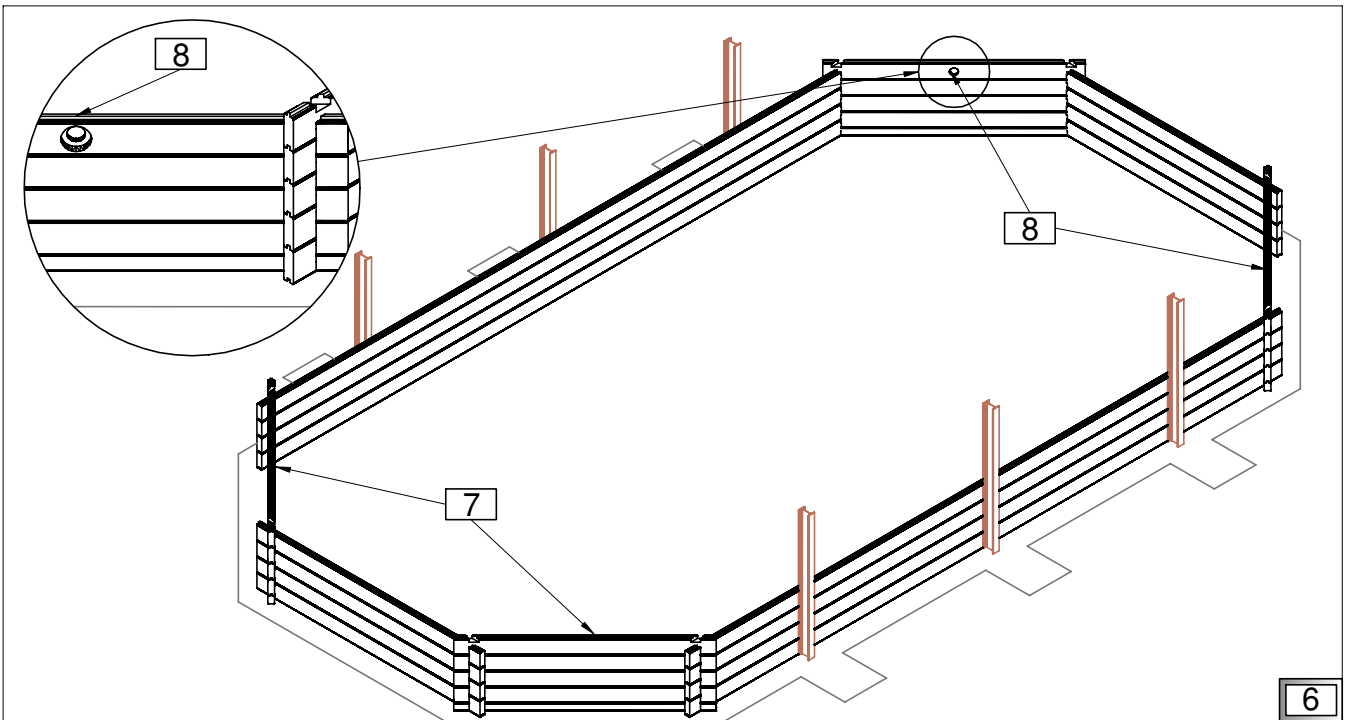



VI-VIII

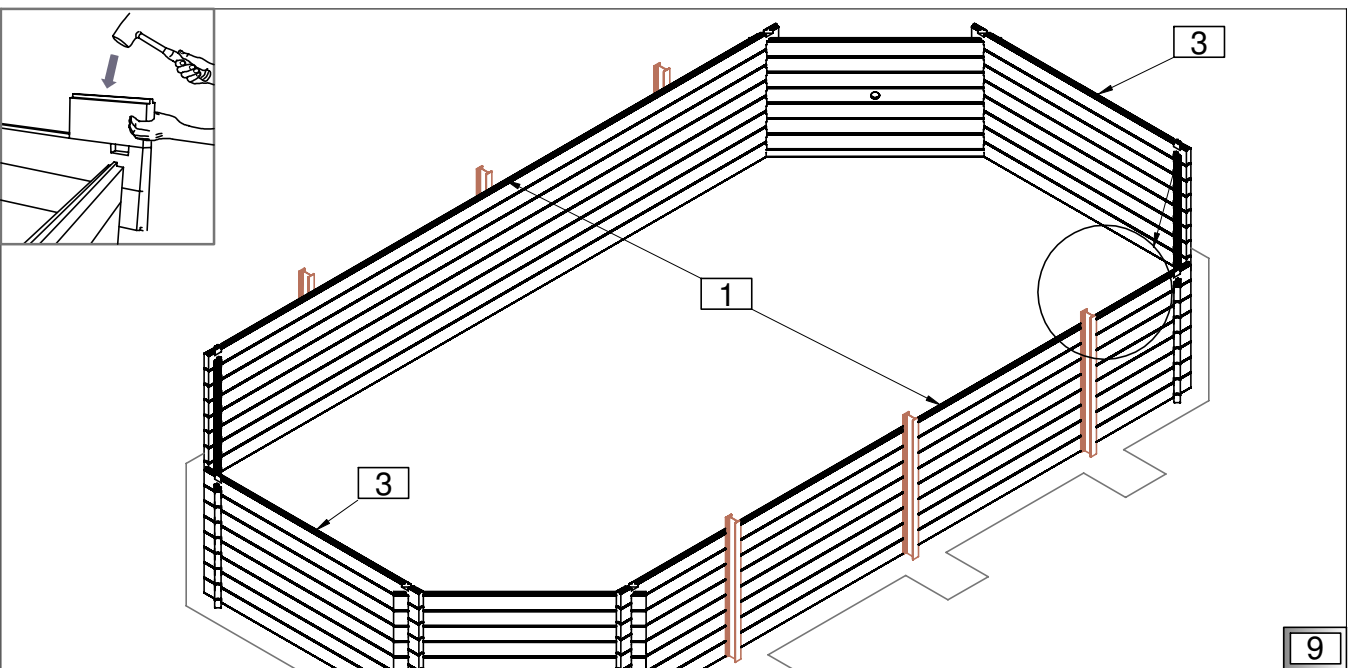
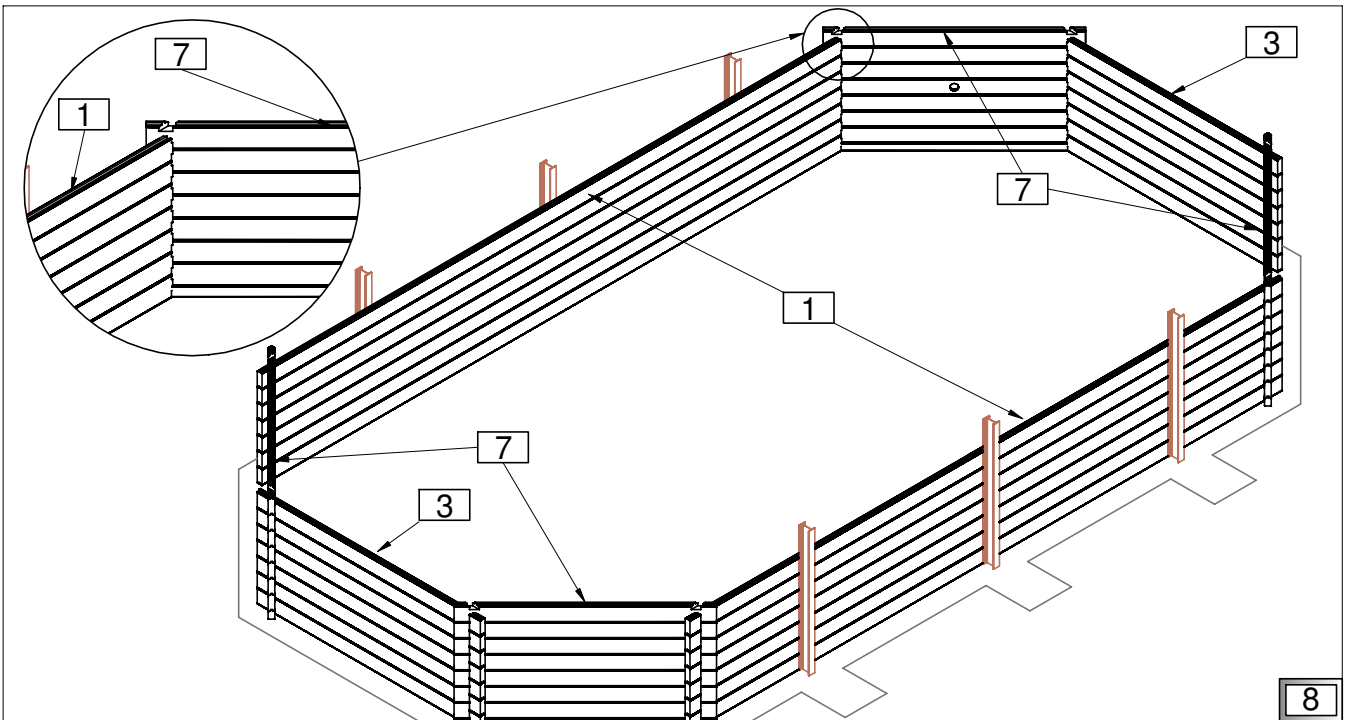
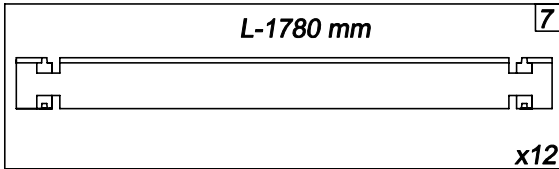
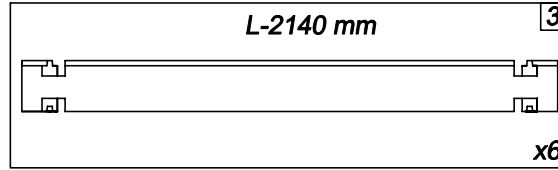
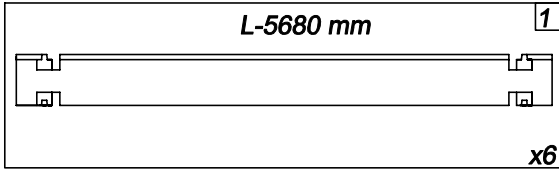



IX

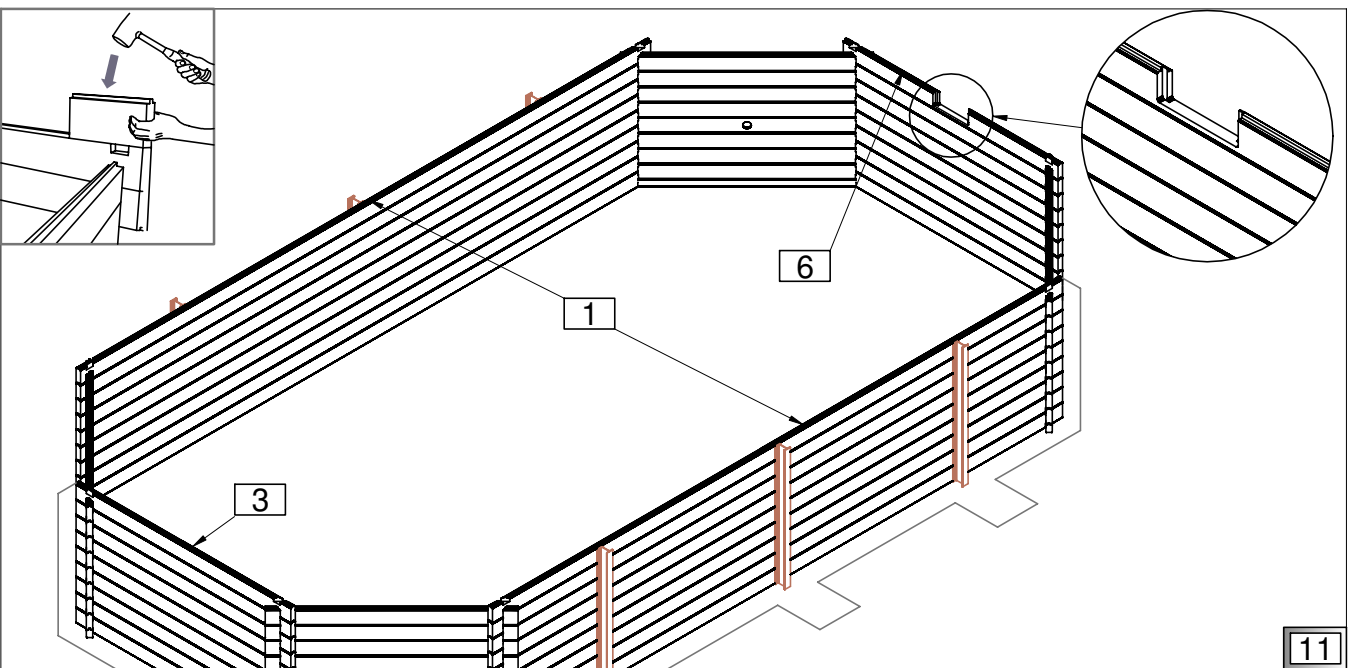
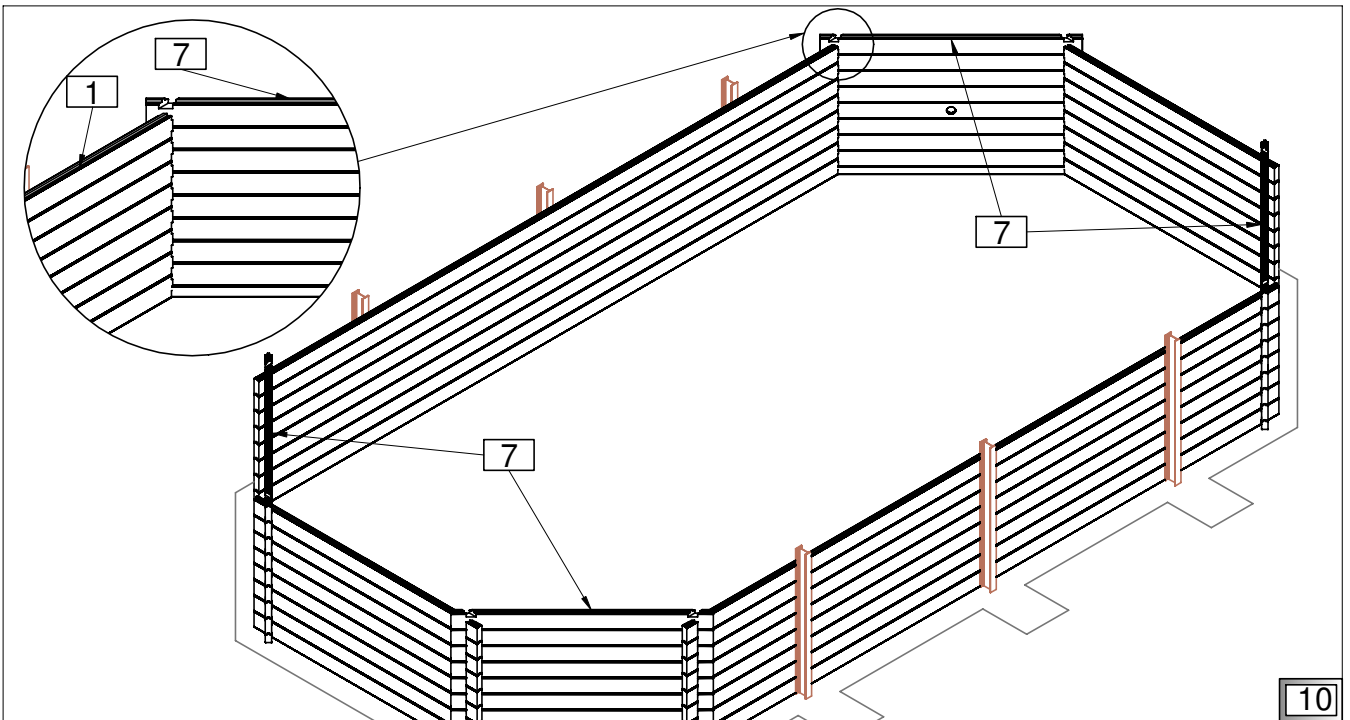
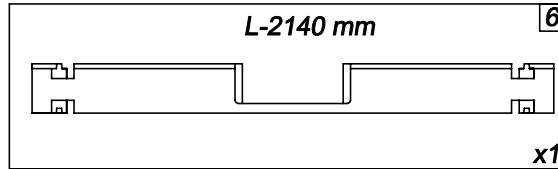
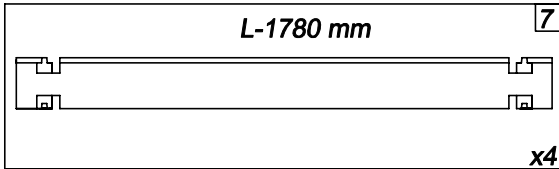
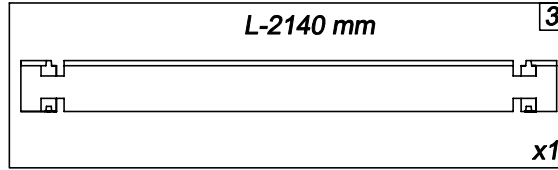
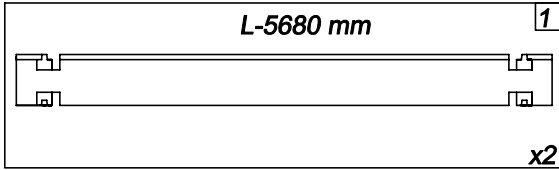

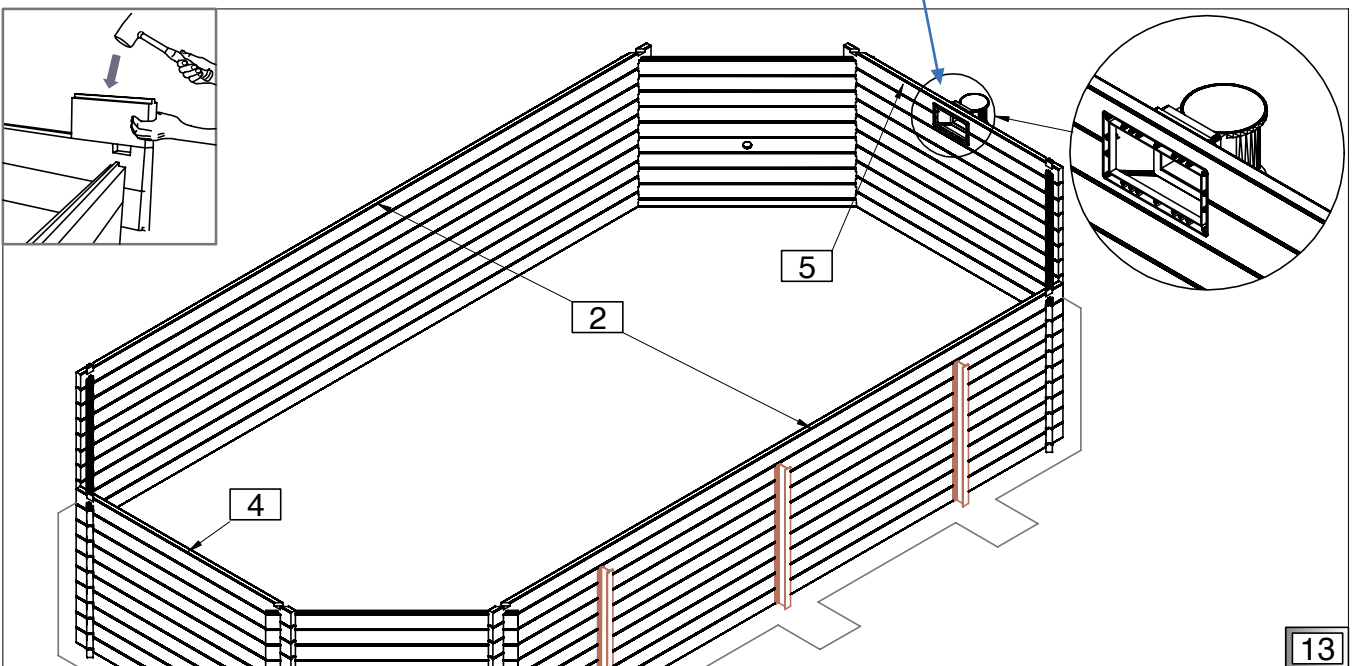
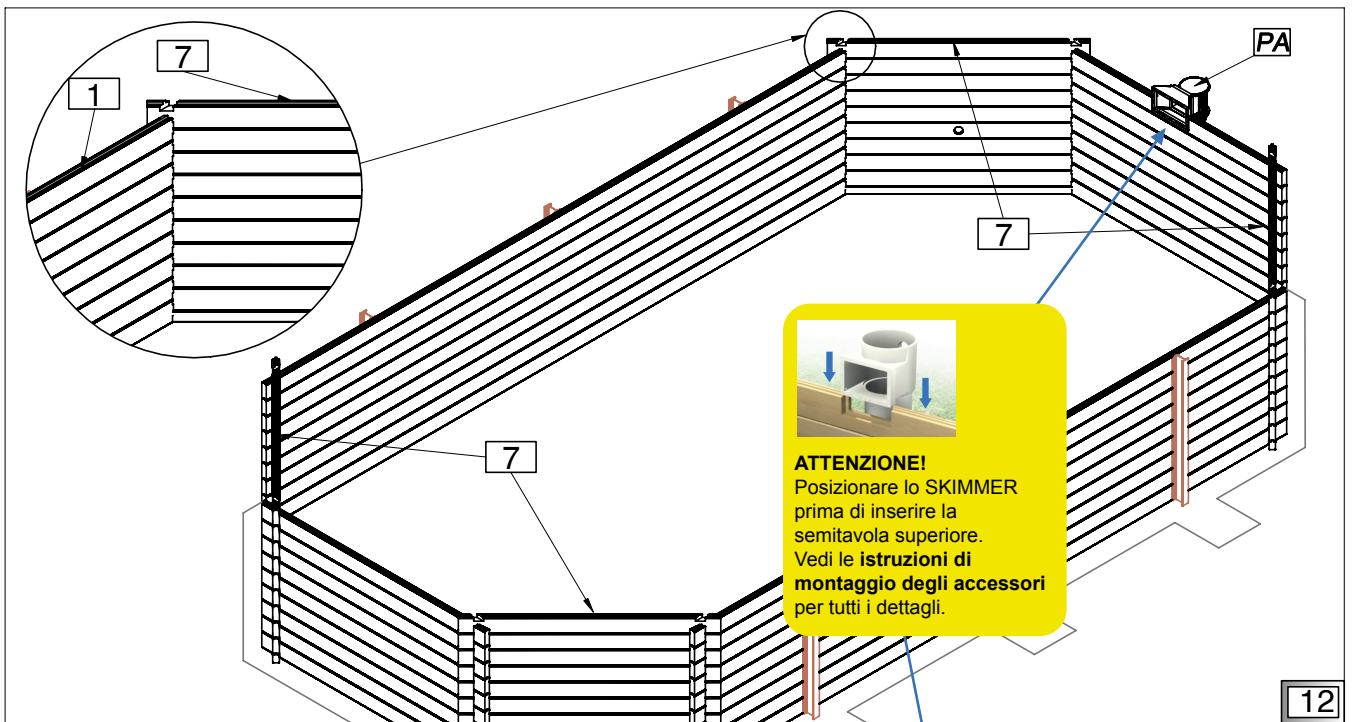
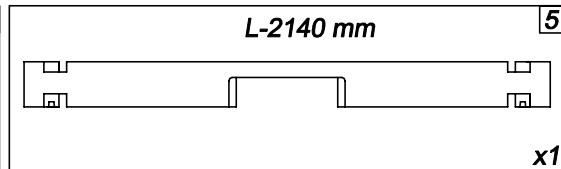
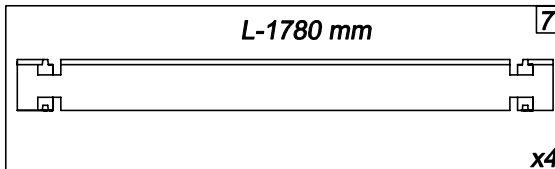
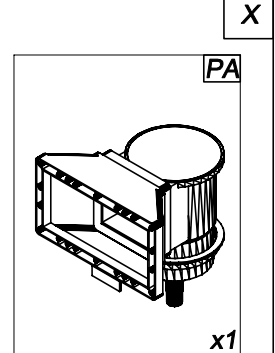
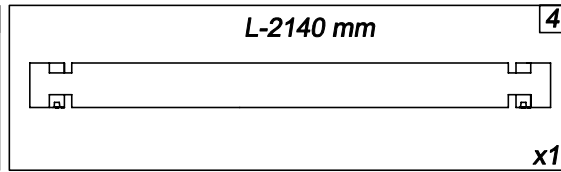
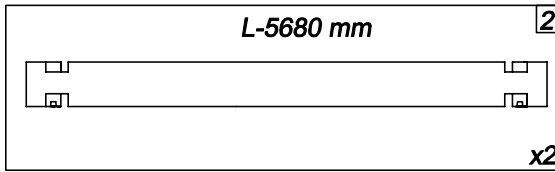



XI

L-1780 mm

9

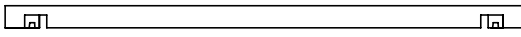

x4

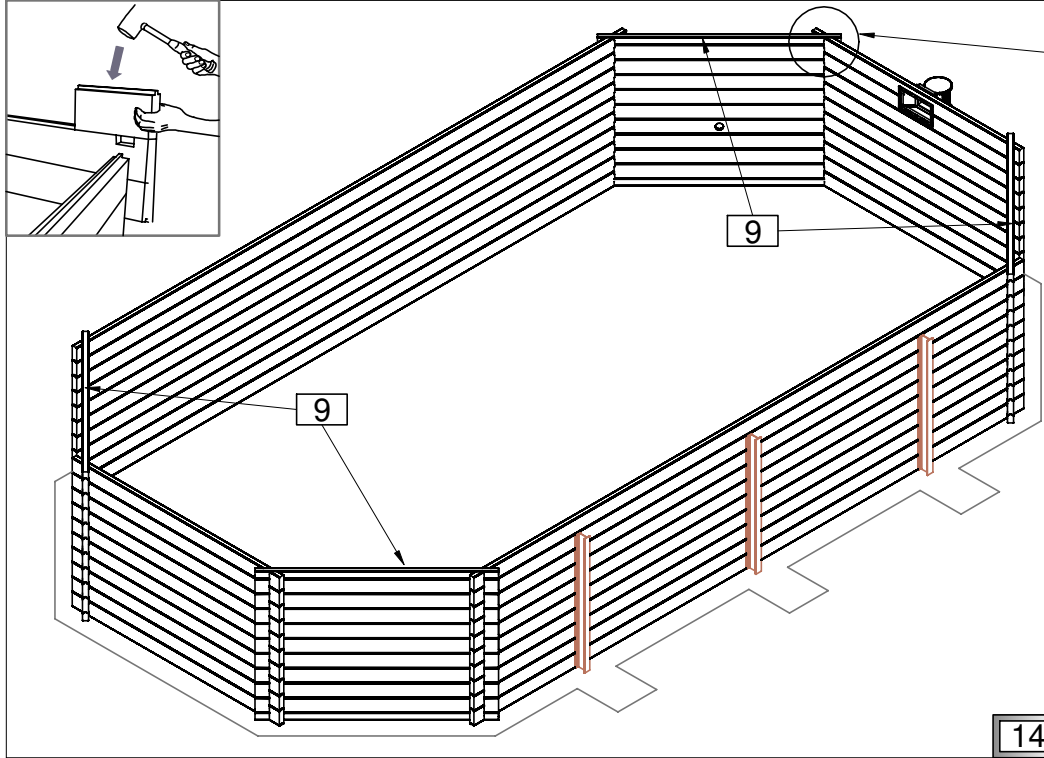
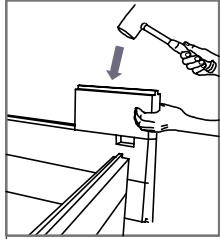

14

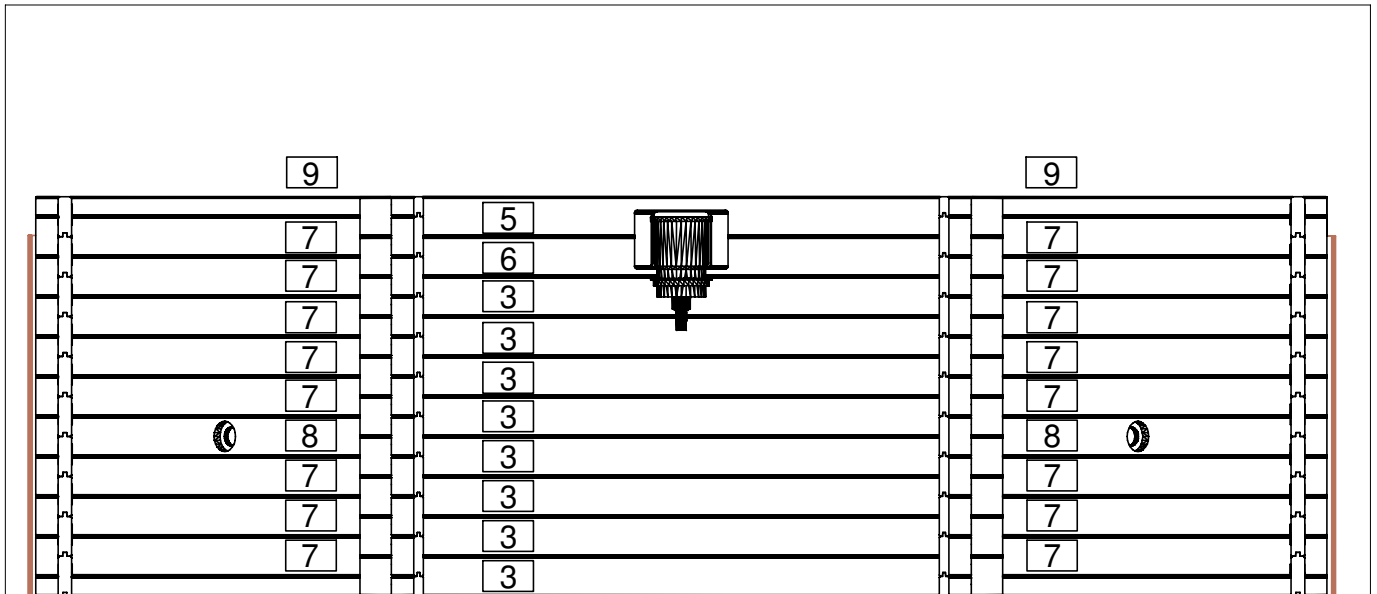

10

10

15

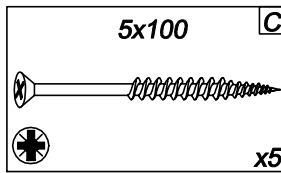
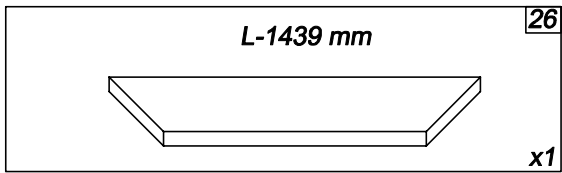

XI

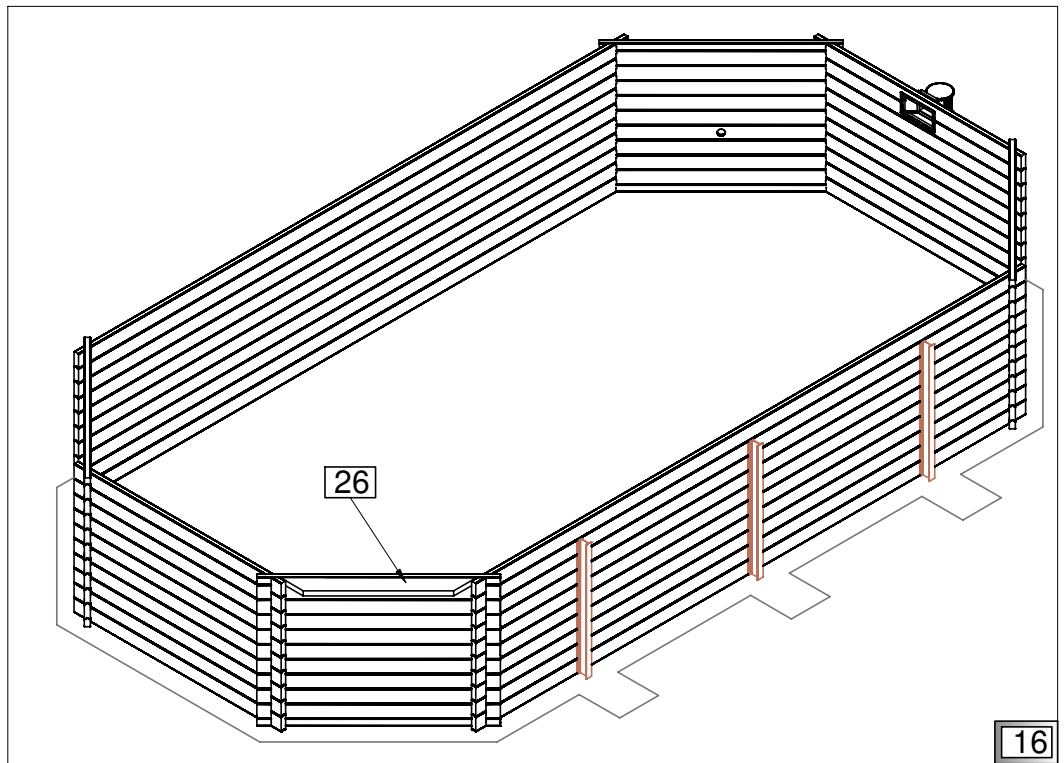

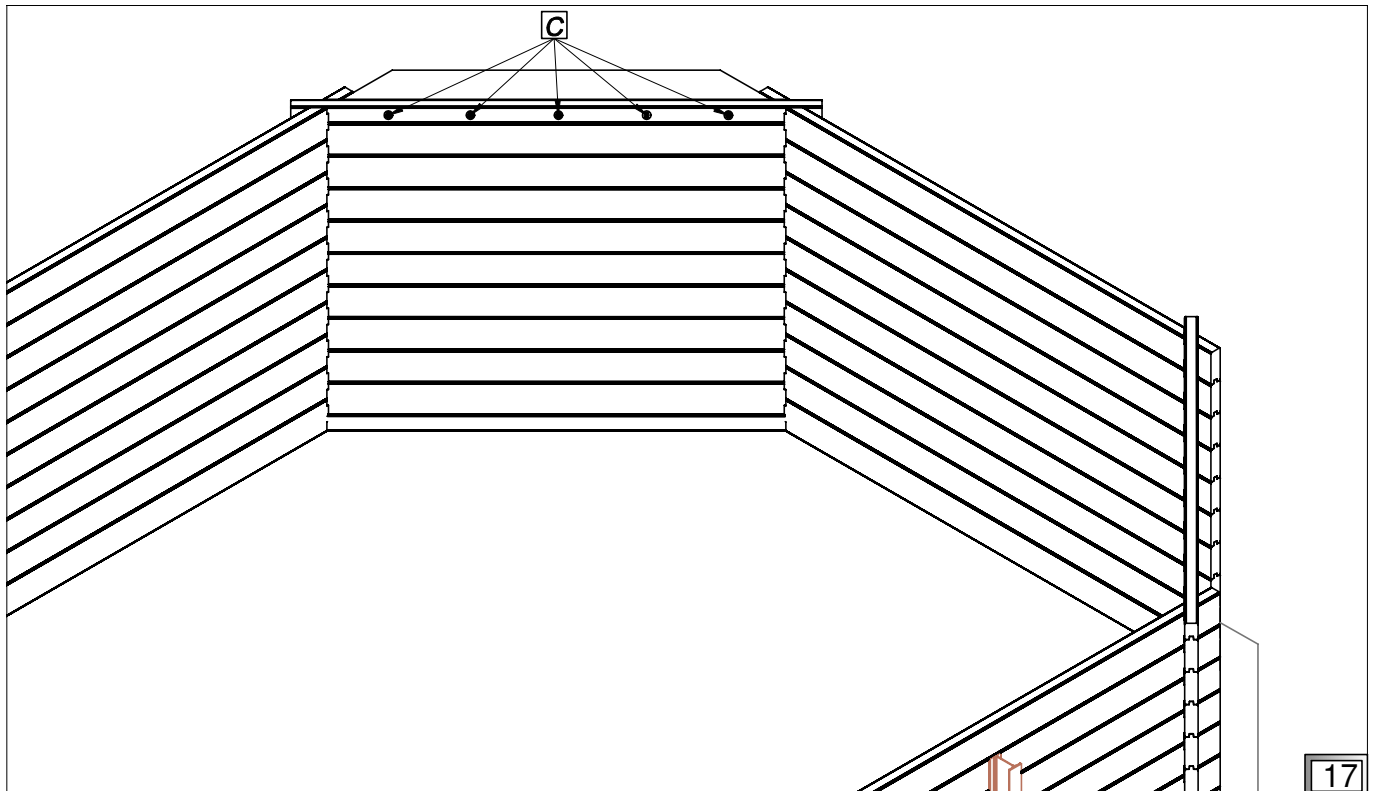

16

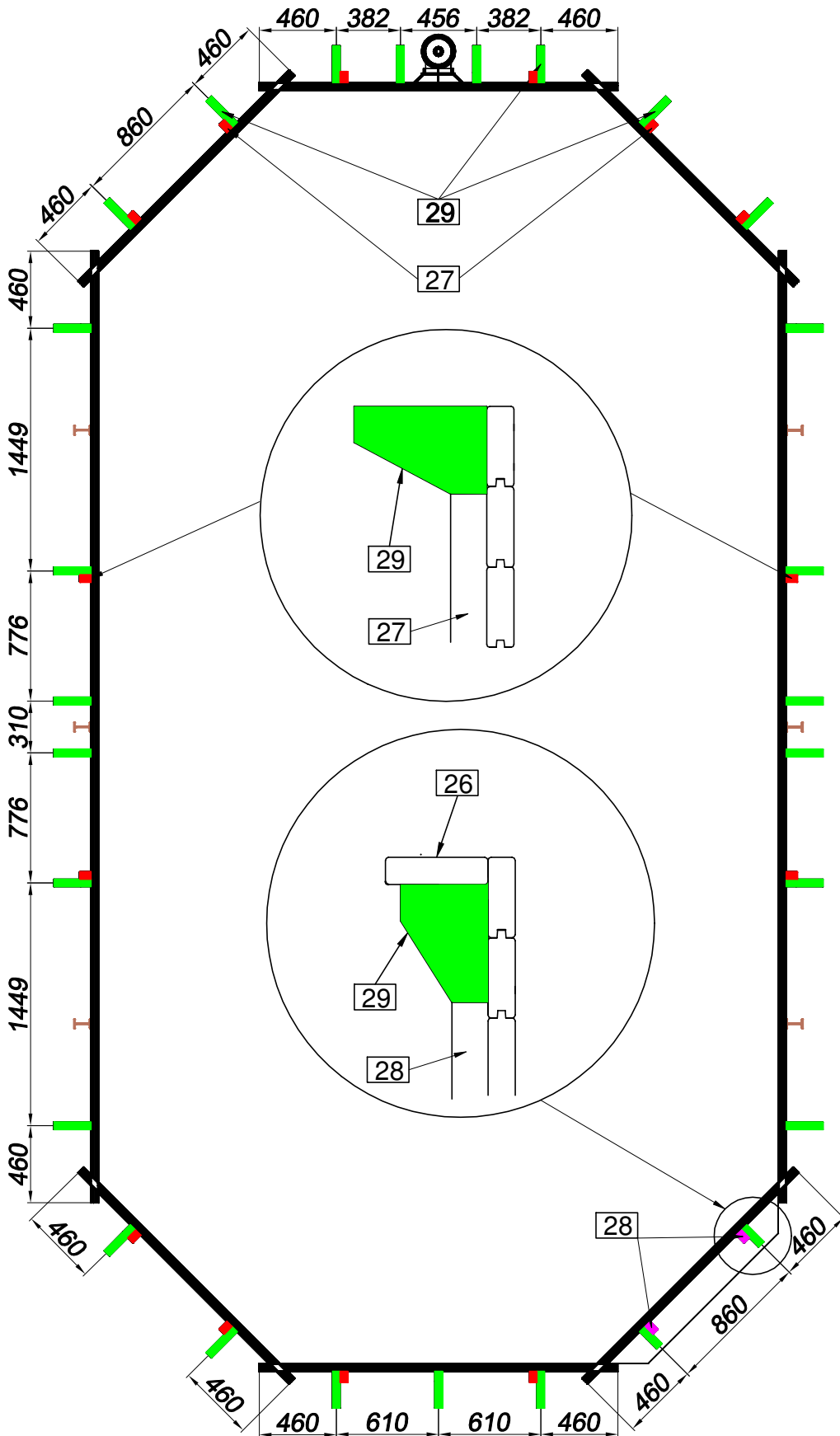

17



-  29
-  27
-  28

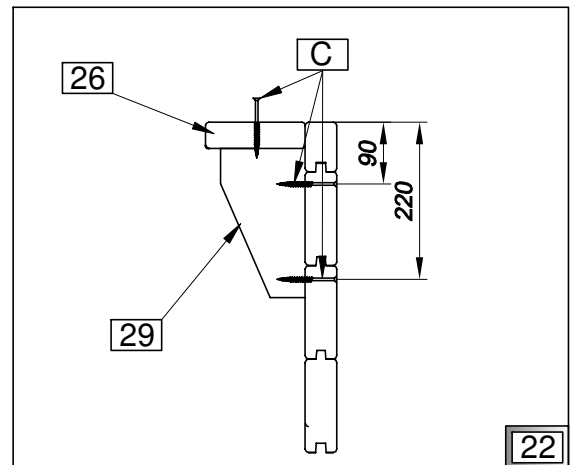
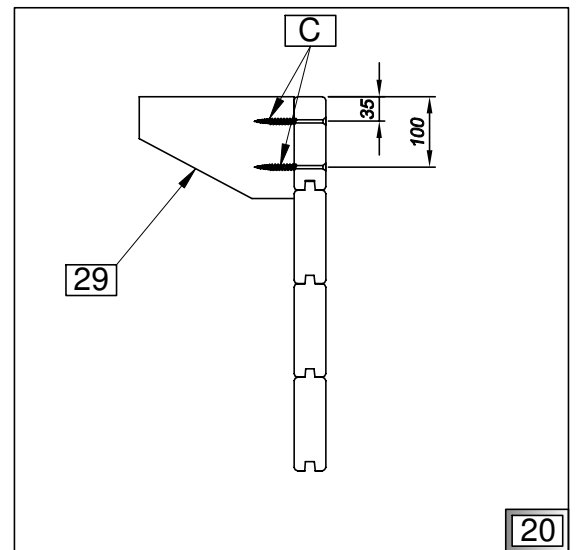
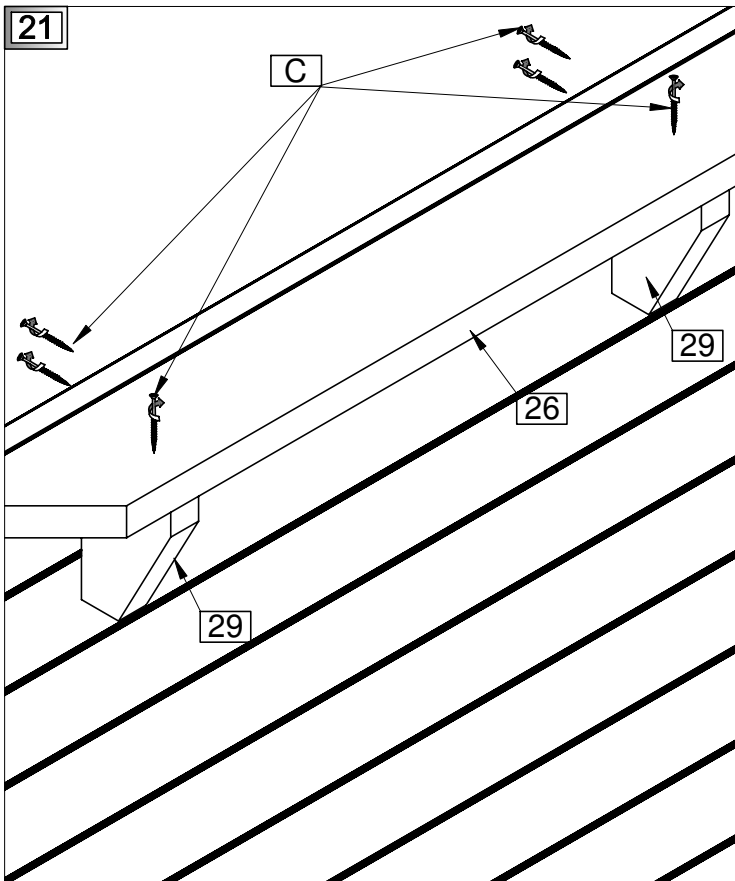
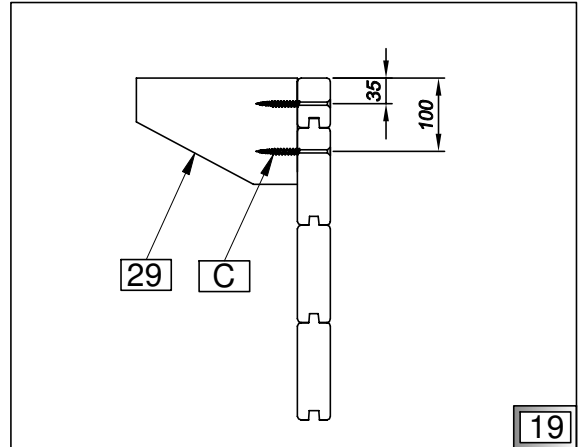
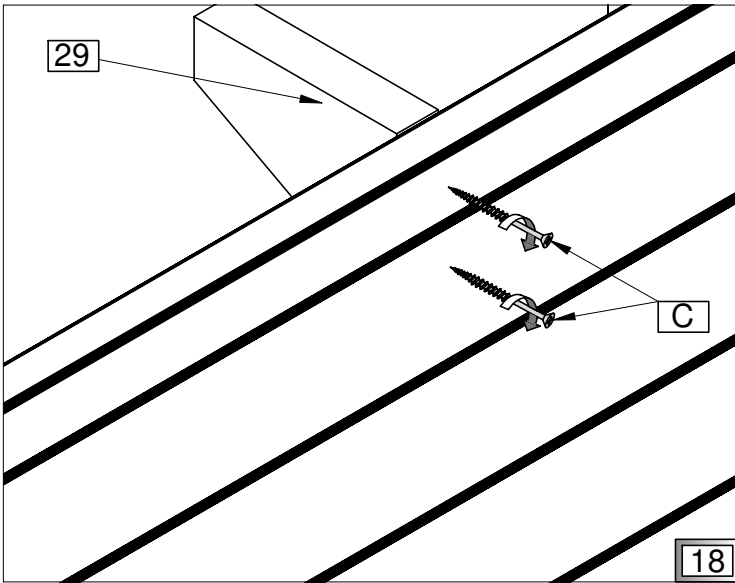
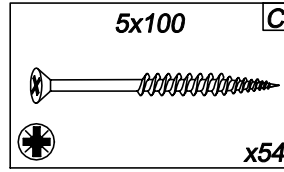
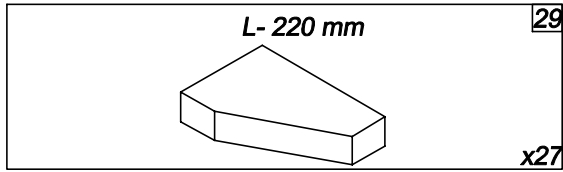

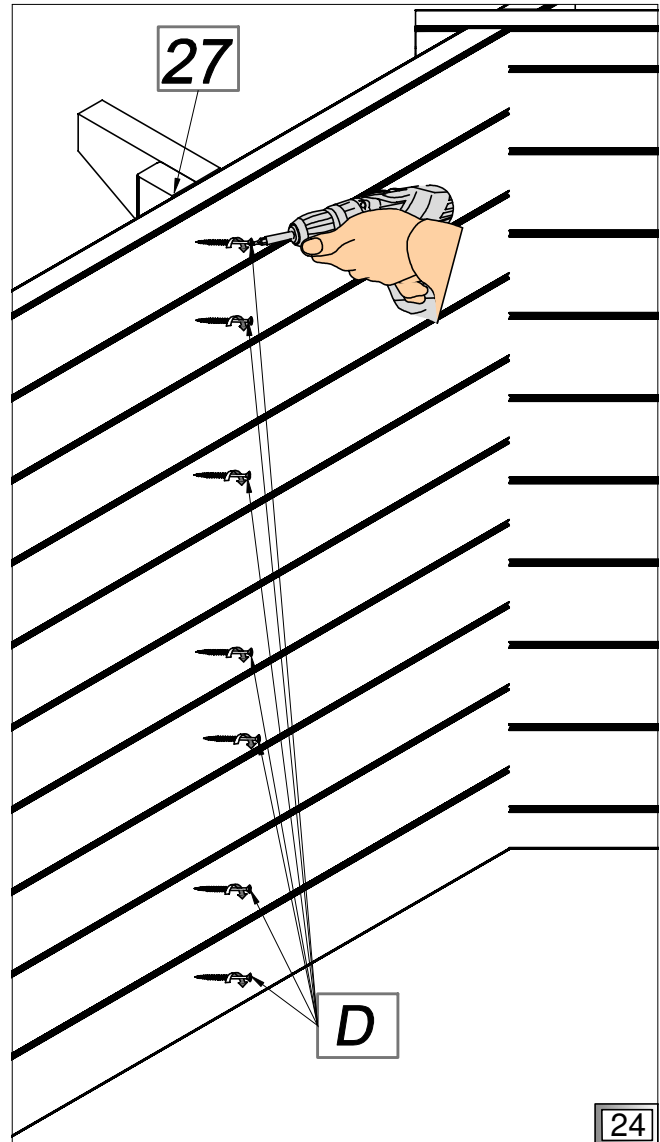
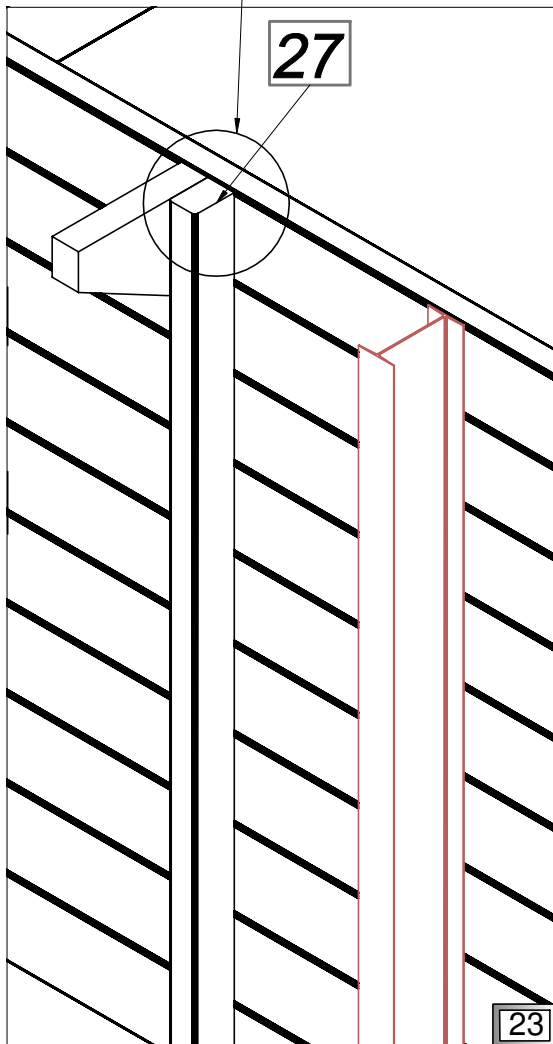
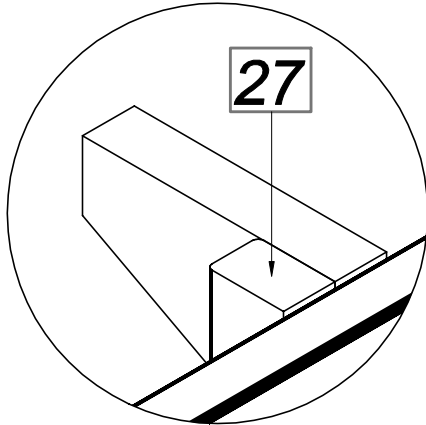
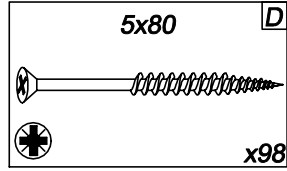
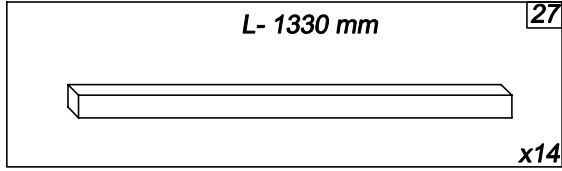

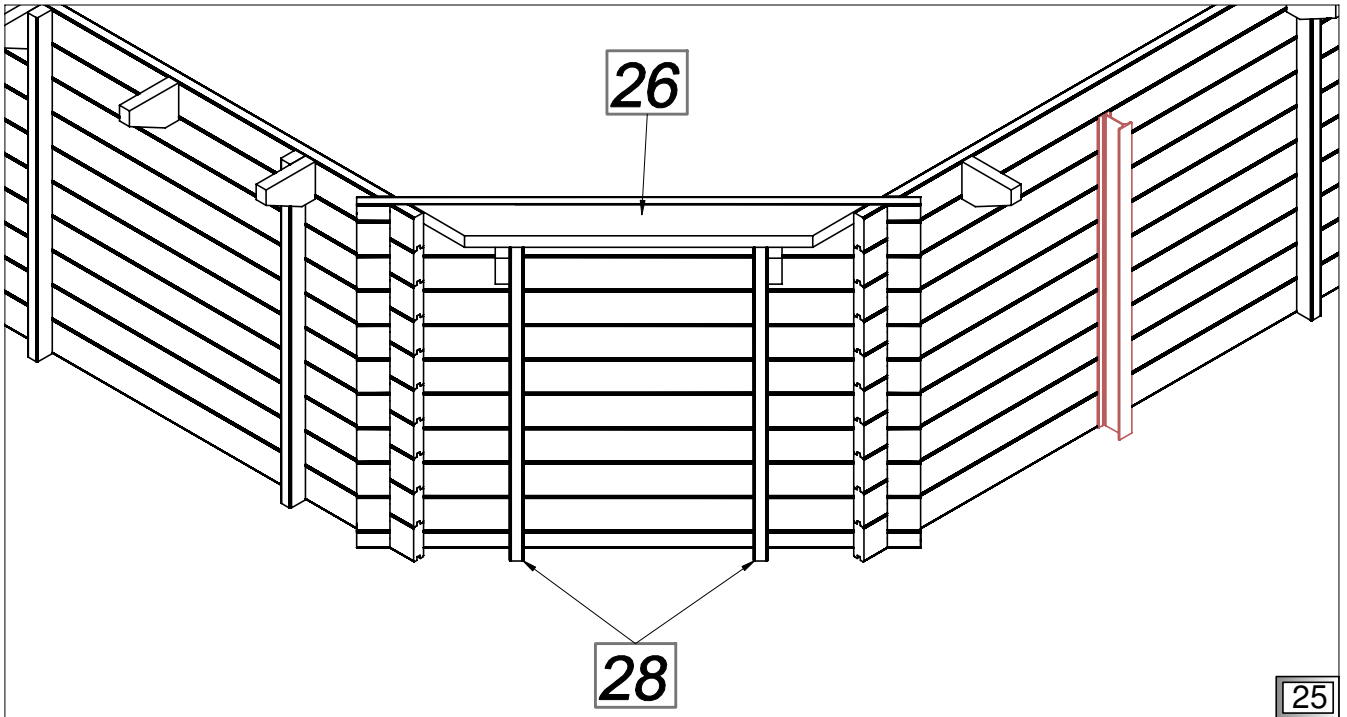
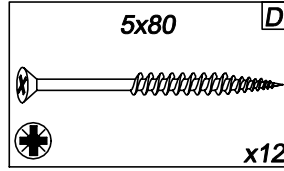
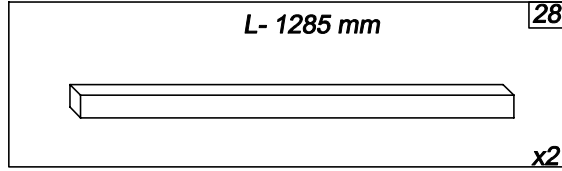

25

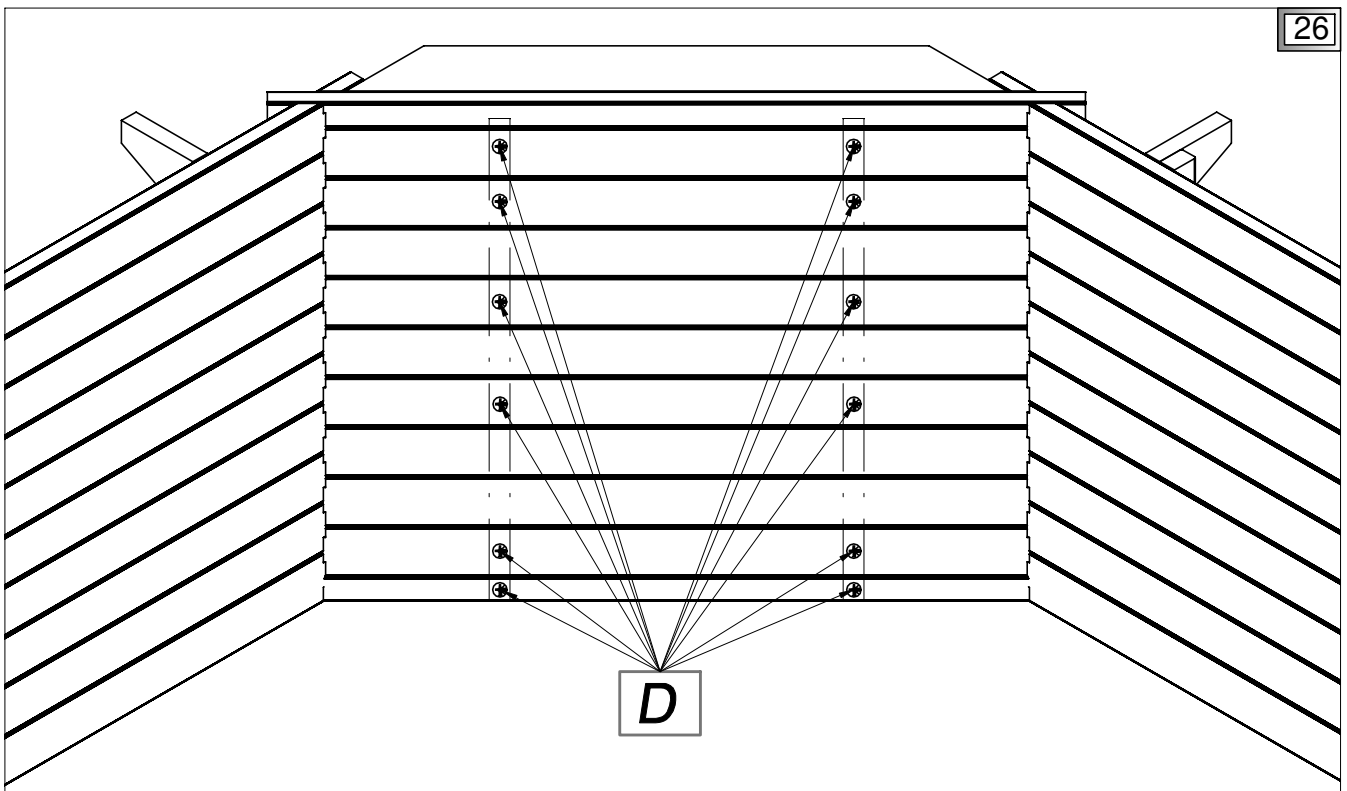

26

D

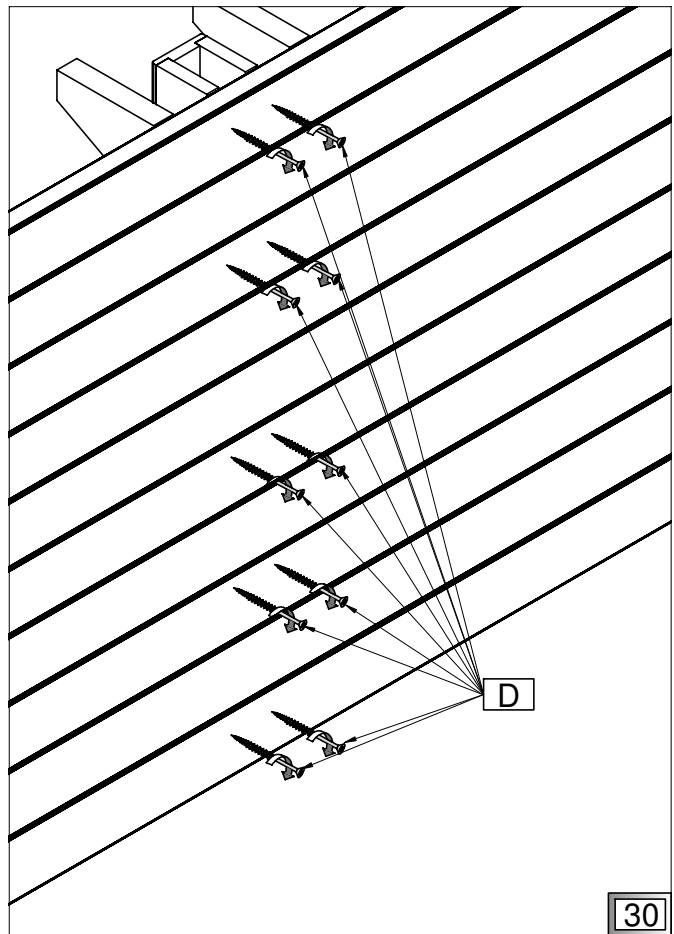
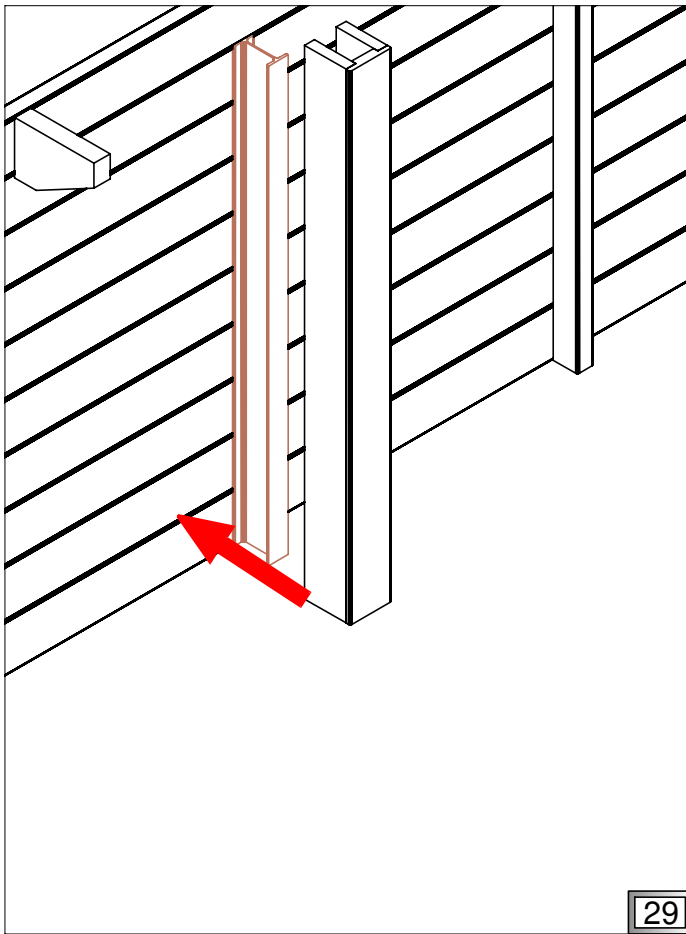
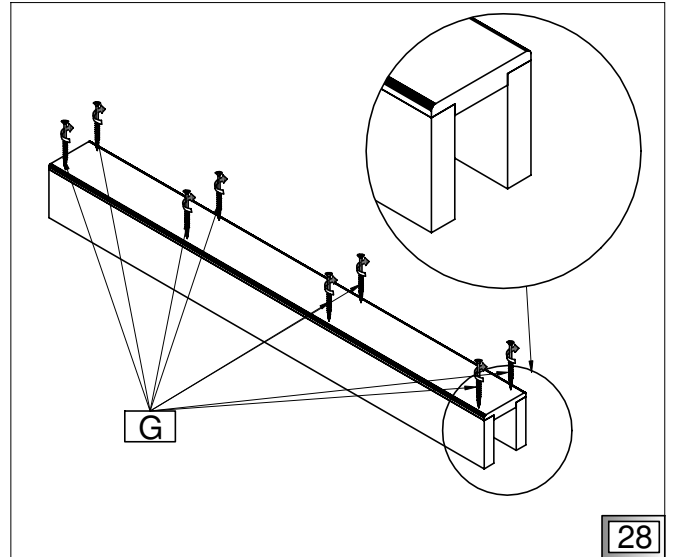
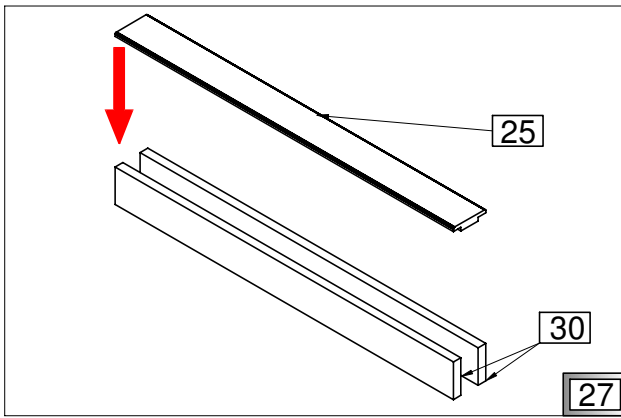
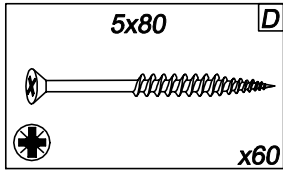
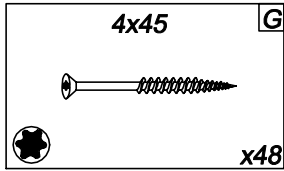
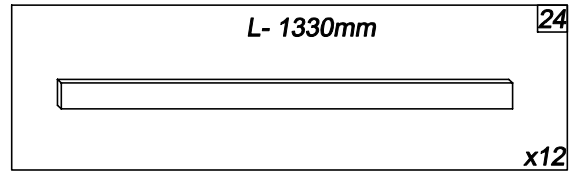
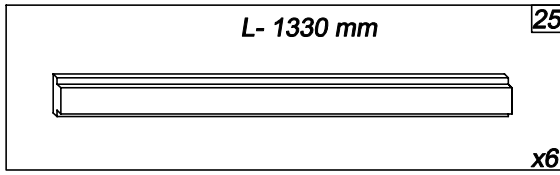

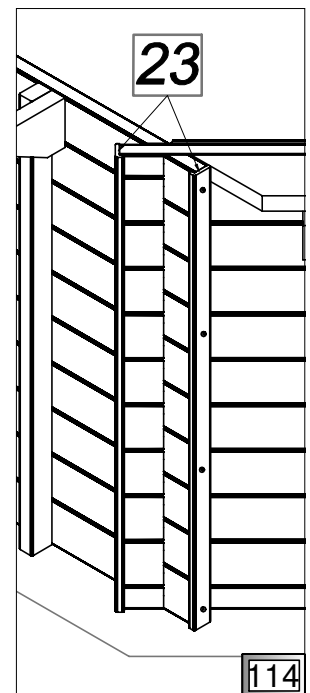
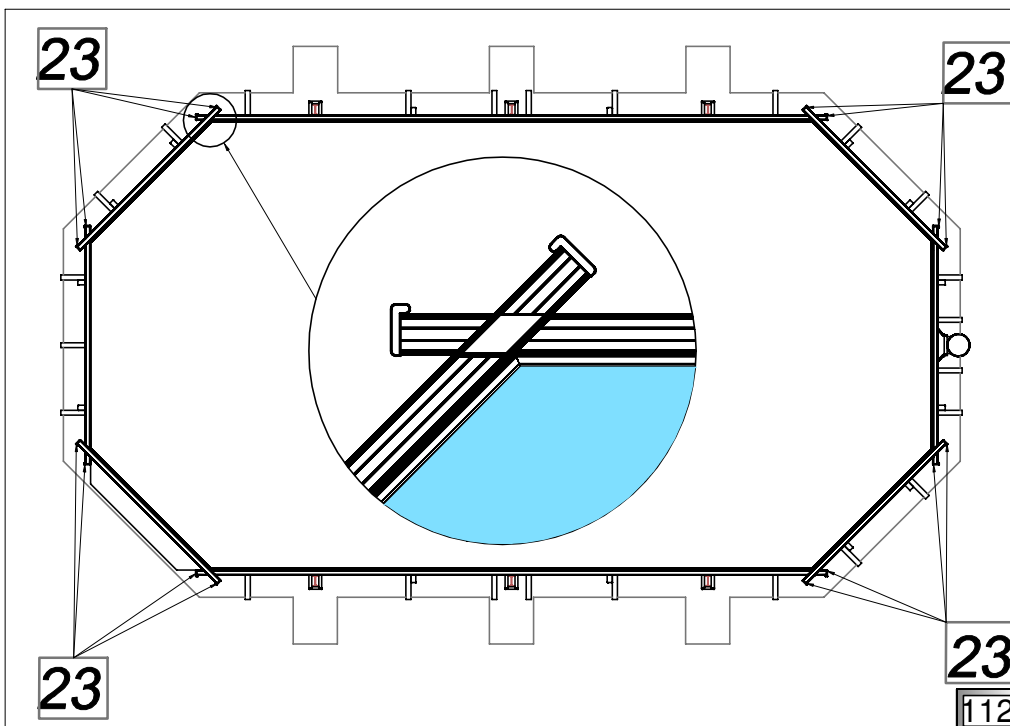
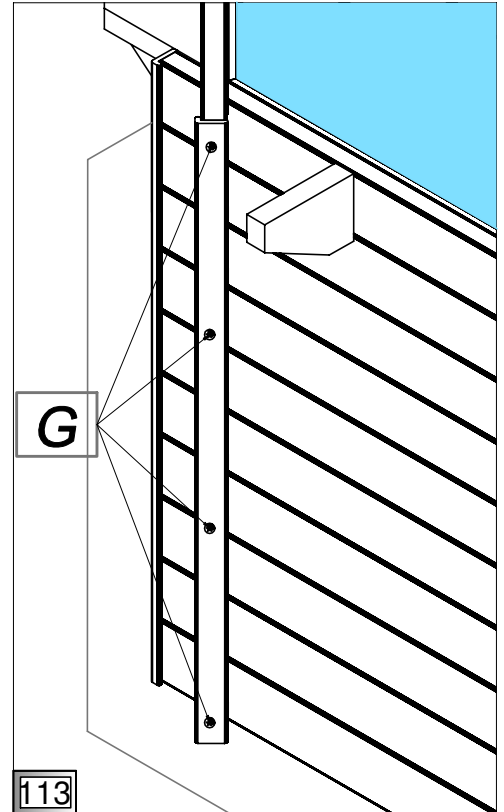
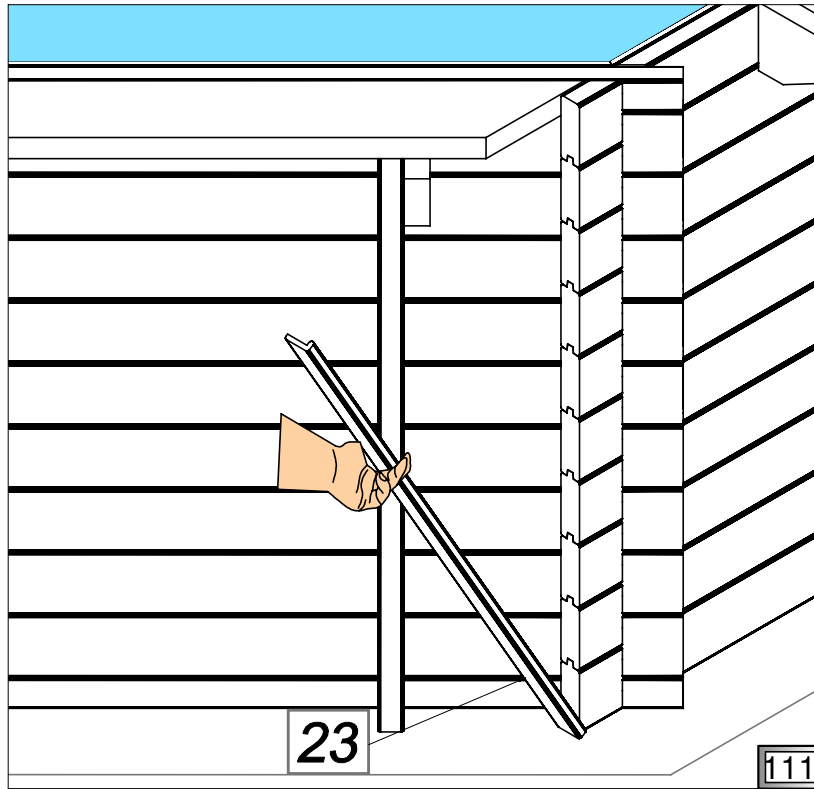
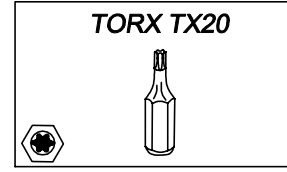
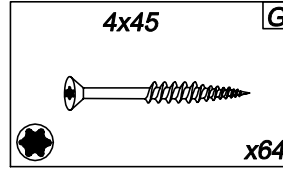
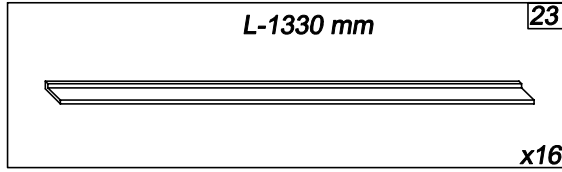

PL Taras

GB Terrace

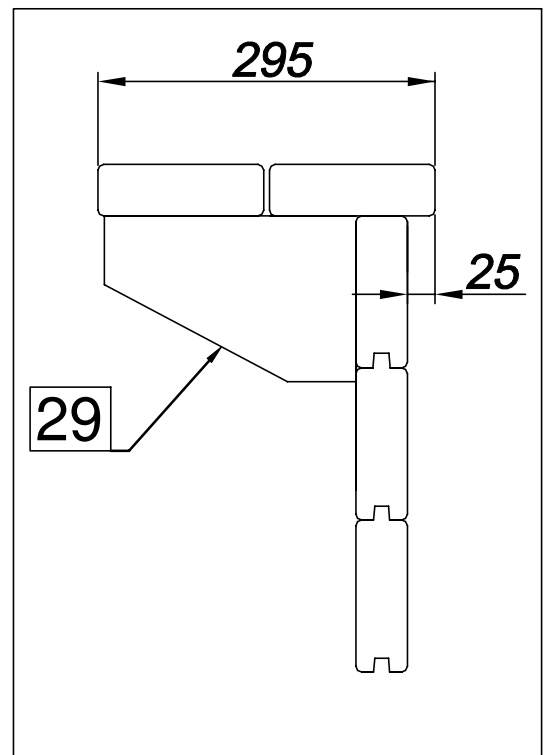
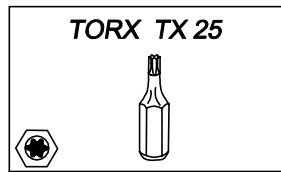
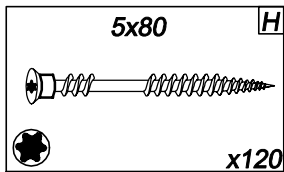
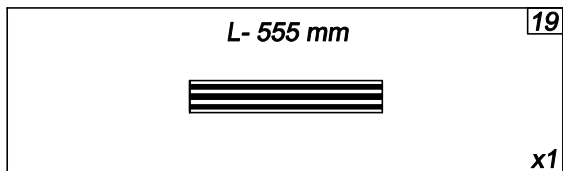
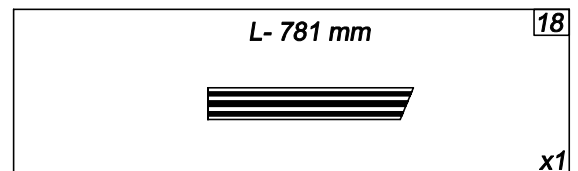
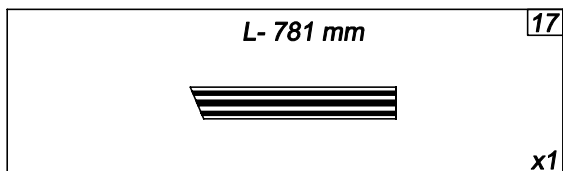
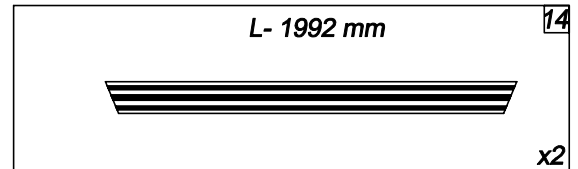
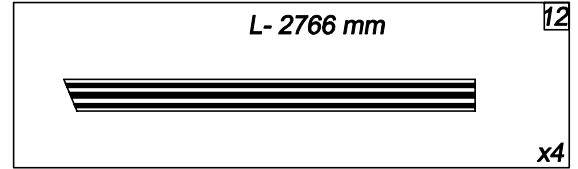
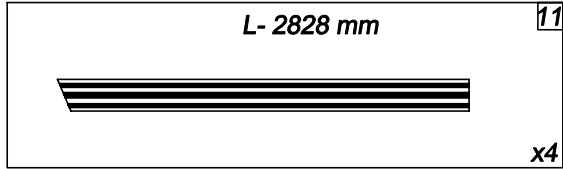

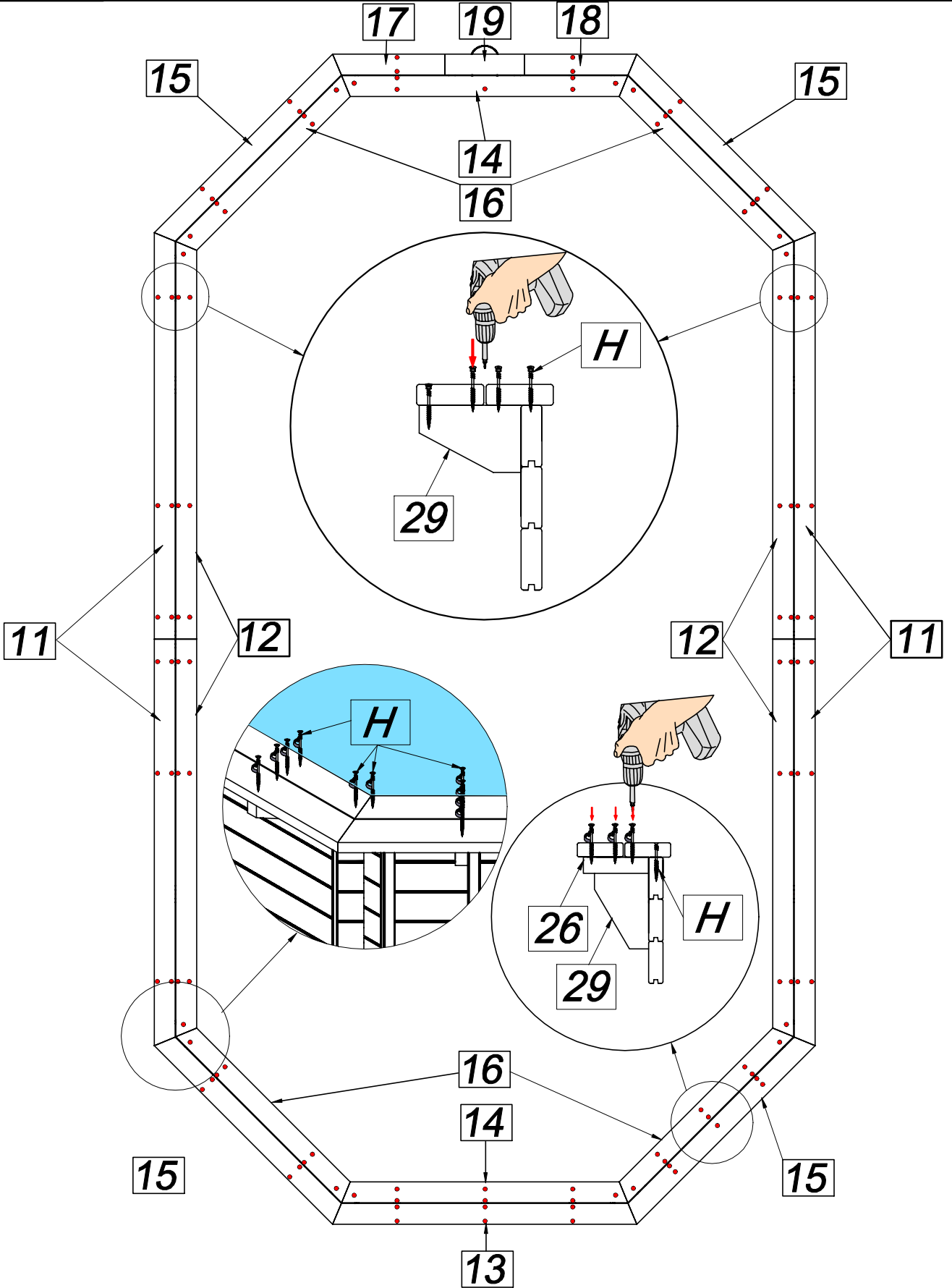

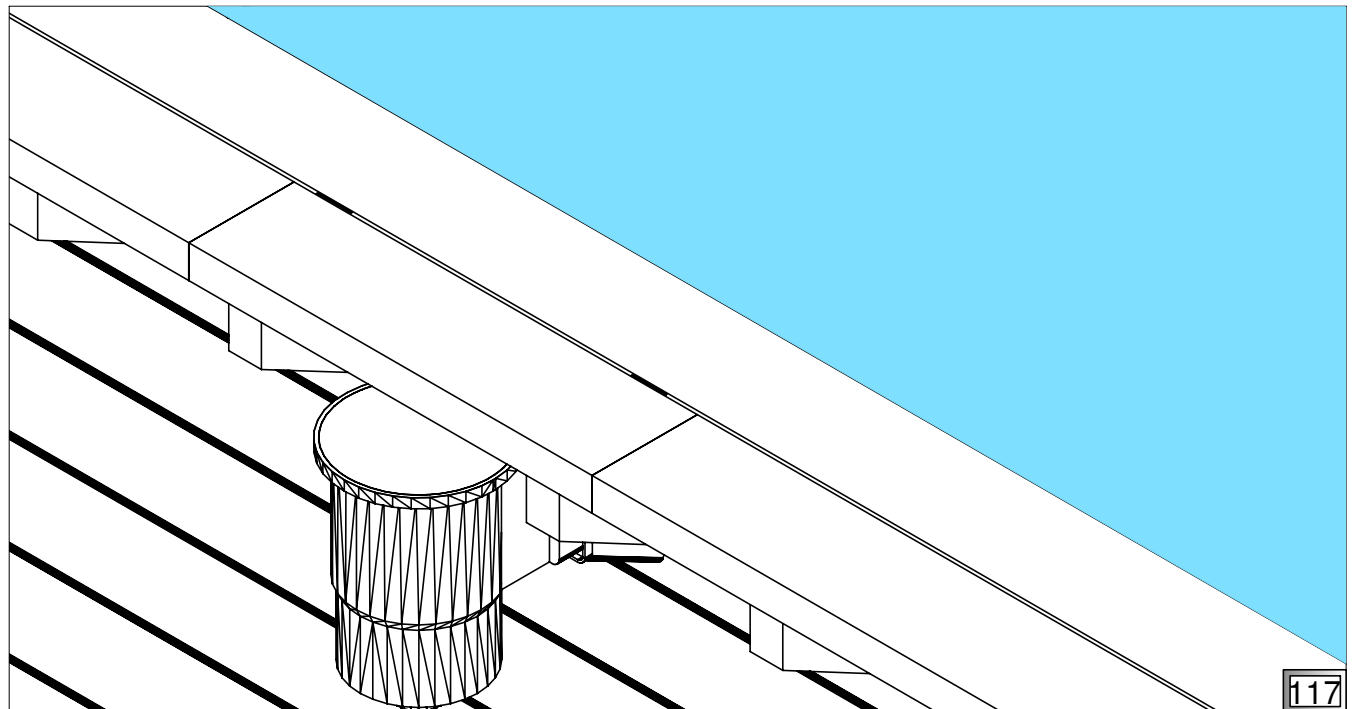
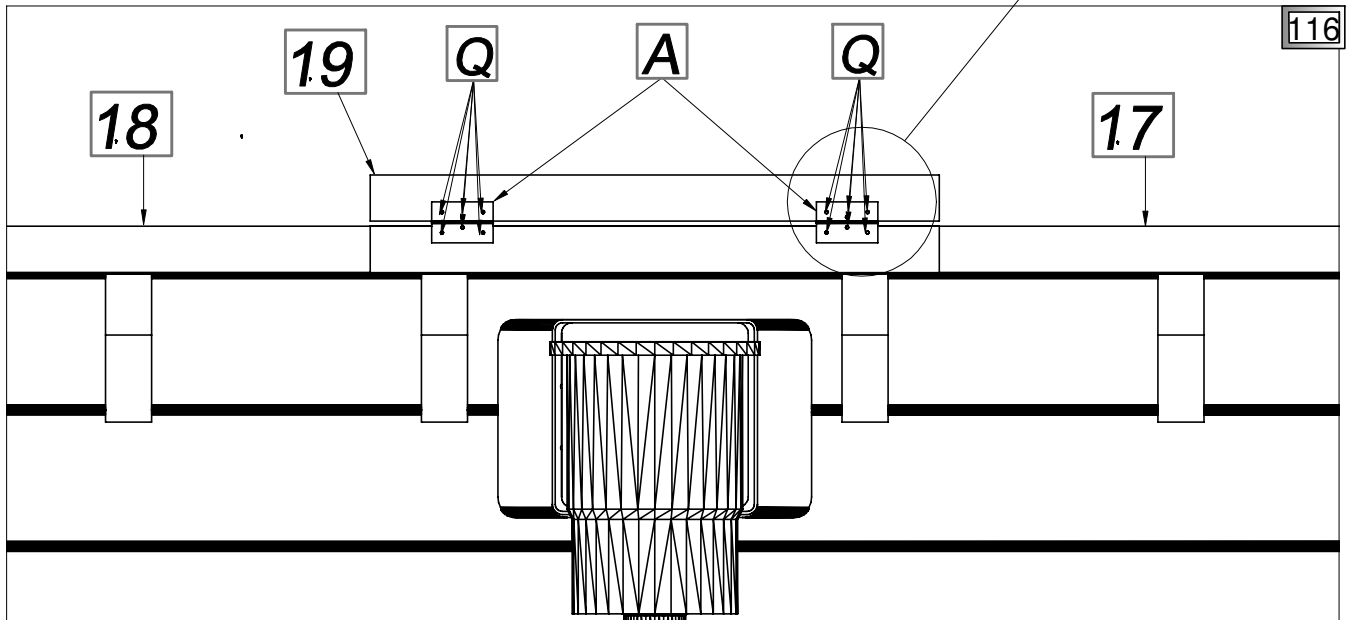
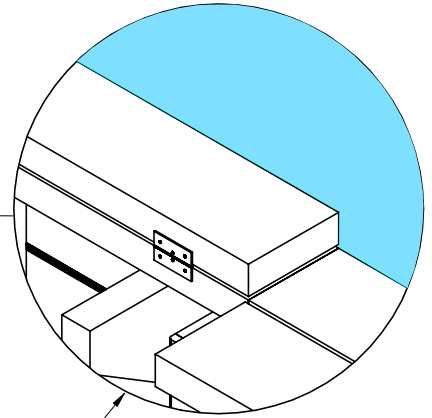
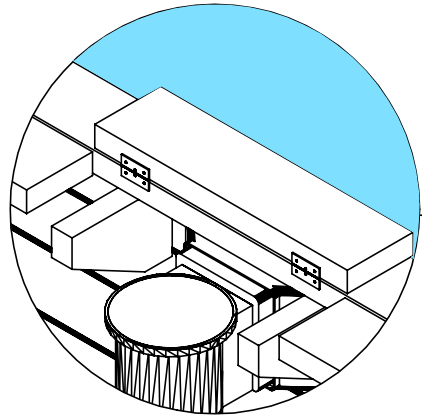
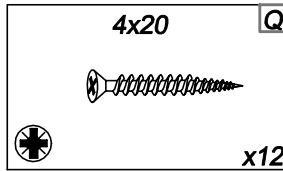
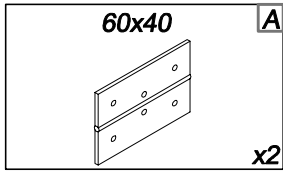

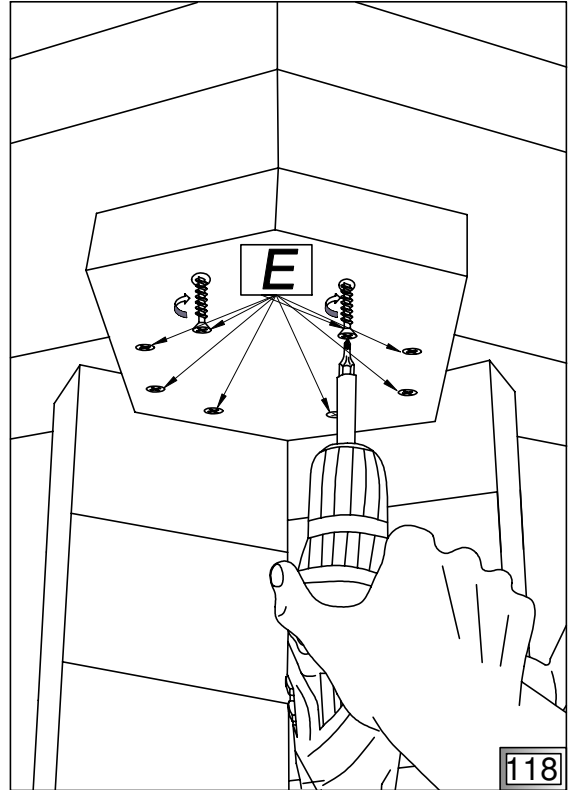
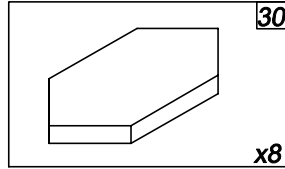
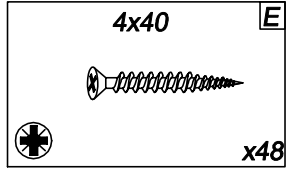

PL Widok od spodu tarasu.

GB View from the bottom of terrace.

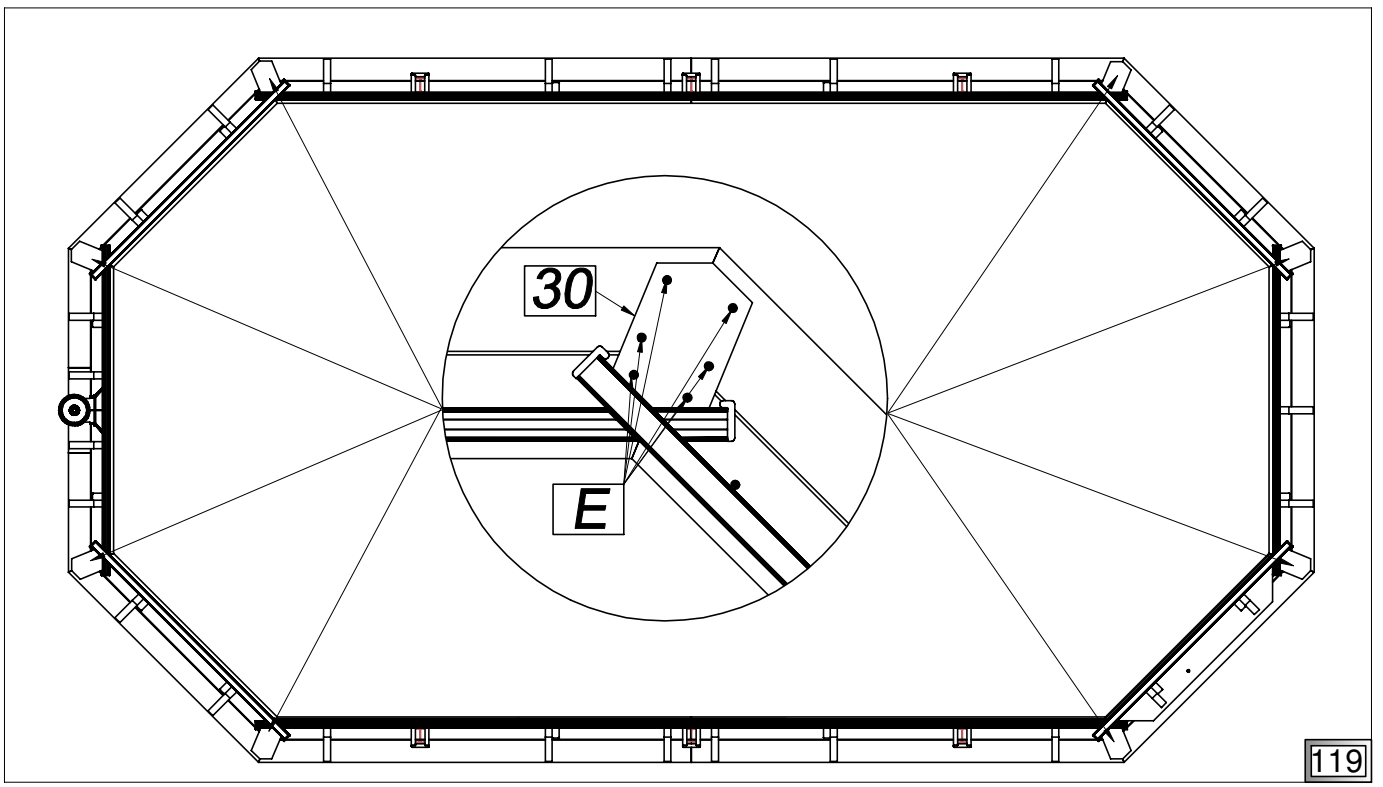

PL Schody drewniane

GB Wooden stairs

